

CONTO D4-Pt Three-phase energy meter

Manuale d'installazione • *Installation manual* • Manuel d'installation
• *Installationsanweisungen* • Manual de instalación





Sommario

Pericoli e avvertenze	4
Operazioni preliminari	6
Presentazione	7
Installazione	8
Utilizzo	12
Programmazione	20
Comunicazione	24
Caratteristiche tecniche	26

Contents

<i>Dangers and warnings</i>	4
<i>Preliminary operations</i>	6
<i>Presentation</i>	7
<i>Installation</i>	8
<i>Use</i>	12
<i>Programming</i>	20
<i>Communication</i>	24
<i>Technical characteristics</i>	28

Sommaire

Danger et avertissement	4
Opérations préalables	6
Présentation	7
Installation	8
Utilisation	12
Programmation	20
Communication	24
Caractéristiques techniques	30

Summary

<i>Gefahren und Warnungen</i>	5
<i>Vorarbeiten</i>	6
<i>Presentation</i>	7
<i>Installieren</i>	8
<i>Verwendung</i>	12
<i>Programmierung</i>	20
<i>Kommunikation</i>	25
<i>Technische Daten</i>	32

Resumida

Advertencia	5
Operaciones previas	6
Presentación	7
Instalación	8
Utilización Programación	12
Programación	20
Comunicación	25
Características técnicas	34

• Pericoli e avvertenze

Questi apparecchi devono essere montati esclusivamente da professionisti.
Il mancato rispetto delle indicazioni contenute nelle presenti istruzioni solleva il fabbricante da ogni responsabilità.

Rischi di folgorazione, ustioni o esplosione

- L'installazione e la manutenzione di questo apparecchio devono essere effettuate esclusivamente da personale qualificato.
 - Prima di qualsiasi intervento sull'apparecchio, escludere gli ingressi di tensione.
 - Utilizzare sempre un opportuno dispositivo di rilevamento di tensione per confermare l'assenza di tensione.
 - Rimontare tutti i dispositivi, i portelli e i coperchi prima di mettere l'apparecchio sotto tensione.
 - Per alimentare questo apparecchio, utilizzare sempre la tensione nominale indicata.
- In caso di mancato rispetto di queste precauzioni, si potrebbero subire gravi ferite.

Rischi di deterioramento dell'apparecchio

Attenzione a rispettare:

- Una tensione ai morsetti degli ingressi di tensione (V1,V2,V3 e N) secondo i valori indicati nella sezione "Caratteristiche tecniche".
- La corrente ai morsetti L1, L2, L3 secondo i valori indicati nelle sezioni
- La frequenza di rete a 50 o 60 Hz.

• Dangers and warnings

*This equipment must only be mounted by professionals.
The manufacturer shall not be held responsible for failure to comply with the instructions in this manual.*

Risk of electrocution, burns or explosion

- *The device must only be installed and serviced by qualified personnel.*
 - *Prior to any work on or in the device, isolate the voltage inputs.*
 - *Always use an appropriate voltage detection device to confirm the absence of voltage.*
 - *Put all mechanisms, door and covers back in place before energising the device.*
 - *Always supply the device with the indicated rated voltage.*
- Failure to take these precautions could cause serious injuries.*

Risk of damaging the device

Chek the following:

- *The voltage to the voltage-input terminals, (V1,V2,V3 and N) according to the values indicated in the "Technical characteristics" section.*
- *The current to terminals L1, L2, L3 according to the values indicated in sections*
- *The frequency of the distribution system (50 or 60 Hz).*

• Danger et avertissement

Le montage de ce produit ne peut être effectué que par des professionnels.
Le non respect des indications de la présente notice ne saurait engager la responsabilité du constructeur.

Risque d'électrocution, de brûlures ou d'explosion

- L'installation et l'entretien de cet appareil ne doivent être effectués que par du personnel qualifié.
- Avant toute intervention sur l'appareil, coupez les entrées tensions.
- Utilisez toujours un dispositif de détection de tension approprié pour confirmer l'absence de tension.
- Remplacez tous les dispositifs, les portes et les couvercles avant de mettre cet appareil sous tension.
- Utilisez toujours la tension assignée appropriée pour alimenter cet appareil.

Si ces précautions n'étaient pas respectées, cela pourrait entraîner des blessures graves.

Risque de détérioration de l'appareil

Veillez à respecter

- Une tension aux bornes des entrées tensions (V1,V2,V3 et N) selon les valeurs indiquées dans la section "Caractéristiques techniques".
- Le courant aux bornes L1, L2, L3 selon les valeurs indiquées dans les sections
- La plage de fréquence du réseau 50 ou 60 Hz.

• Gefahren und Warnungen

*Diese Geräte dürfen nur von Fachleuten montiert werden.
Die Nichtbeachtung der vorliegenden Anweisungen entbindet den Hersteller von jeglicher Haftung.*

Stromschlag-, Verbrennungs- und Explosionsgefahr

- Die Installation und Wartung dürfen nur von qualifizierten Fachleuten vorgenommen werden.
 - Vor jedem Eingriff in das Gerät sind die Spannungseingänge auszuschließen.
 - Verwenden Sie immer ein geeignetes Spannungsmessgerät, um die Spannungsfreiheit zu überprüfen.
 - Alle Geräte, Türen und Abdeckungen wieder montieren, bevor Sie das Gerät unter Spannung setzen.
 - Verwenden Sie immer die angegebene Nennspannung, um das Gerät mit Strom zu versorgen.
- Die Nichtbeachtung dieser Vorsichtsmaßnahmen kann zu schweren Verletzungen führen.*

Beschädigungsgefahr des Gerätes

Bitte beachten:

- Eine Spannung an den Klemmen der Spannungseingänge (V1, V2, V3 und N) entsprechend den im Kapitel "Technische Daten" angegebenen Werten.
- Der Strom an den Klemmen L1, L2, L3 gemäß den in den Abschnitten angegebenen Werten
- Netzfrequenz 50/60 Hz

• Advertencia

El montaje de esto materiales sólo puede ser efectuado por profesionales.
No respetar las indicaciones del presente manual exime de responsabilidad al fabricante.

Riesgo de electrocución, de quemaduras o de explosión

- La instalación y mantenimiento de este aparato debe ser efectuado por personal cualificado.
- Antes de cualquier intervención en el aparato, cortar sus entradas de tensión.
- Utilizar siempre un dispositivo de detección de tensión apropiado para asegurar la ausencia de tensión.
- Volver a colocar todos los dispositivos, tapas y puertas antes de poner el aparato en tensión.
- Utilizar siempre la tensión asignada apropiada para alimentar el aparato.

No respetar estas precauciones podría entrañar un serio riesgo de producir heridas graves.

Riesgo de deterioros de aparato

Se ha de respetar:

- Una tensión en los bornes de las entradas de tensión (V1, V2, V3 y N) según los valores indicados en la sección "Características técnicas".
- La corriente en los terminales L1, L2, L3 de acuerdo con los valores indicados en las secciones
- La frecuencia de red a 50/60 Hz

• Operazioni preliminari

Per la sicurezza del personale e del materiale, è indispensabile leggere attentamente il contenuto del presente libretto prima della messa in servizio.

Al momento del ricevimento della scatola contenente il dispositivo, è necessario verificare i seguenti punti:

- lo stato dell'imballo;
- l'assenza di danneggiamenti o rotture dovuti al trasporto;
- la rispondenza tra codice dell'apparecchio e codice ordinato;
- la presenza nell'imballo sia dell'articolo che del foglio istruzioni.

• Preliminary operations

For personnel and product safety read the contents of these operating instructions carefully before connecting.

Check the following points as soon as you receive the box containing the device:

- *the packing is in good condition;*
- *the product has not been damaged or broken during transport;*
- *the product reference number conforms to your order;*
- *the package contains both the item and the operating instructions.*

• Opérations préalables

Pour la sécurité du personnel et du matériel, il est impératif de bien s'imprégner du contenu de cette notice avant la mise en service.

Au moment de la réception du colis contenant le produit, il est nécessaire de vérifier les points suivants :

- l'état de l'emballage ;
- le produit n'a pas eu de dommage pendant le transport ;
- la référence de l'appareil est conforme à votre commande
- l'emballage comprend le produit ;
- une notice d'utilisation.

• Vorarbeiten

Für die Sicherheit von Personen und Material ist es unerlässlich, den Inhalt dieser Anleitung vor der Inbetriebnahme aufmerksam zu lesen. Nach Erhalt der Schachtel mit dem Gerät sind die folgenden Punkte zu überprüfen:

- *Zustand der Verpackung;*
- *Das Fehlen von Beschädigungen oder Bruch durch den Transport;*
- *die Übereinstimmung zwischen Gerätecode und bestelltem Code;*
- *Vorhandensein in der Verpackung sowohl des Artikels als auch der Gebrauchsanweisung.*

• Operaciones previas

Para la seguridad del personal y del material, será imperativo conocer perfectamente el contenido de este manual antes de su puesta en funcionamiento.

Al recibir el paquete que contiene el producto será necesario verificar los aspectos siguientes:

- estado del embalaje;
- que el producto no se haya dañado durante el transporte;
- que la referencia del aparato esté conforme con su pedido;
- el embalaje incluye el producto;
- el manual de utilización.

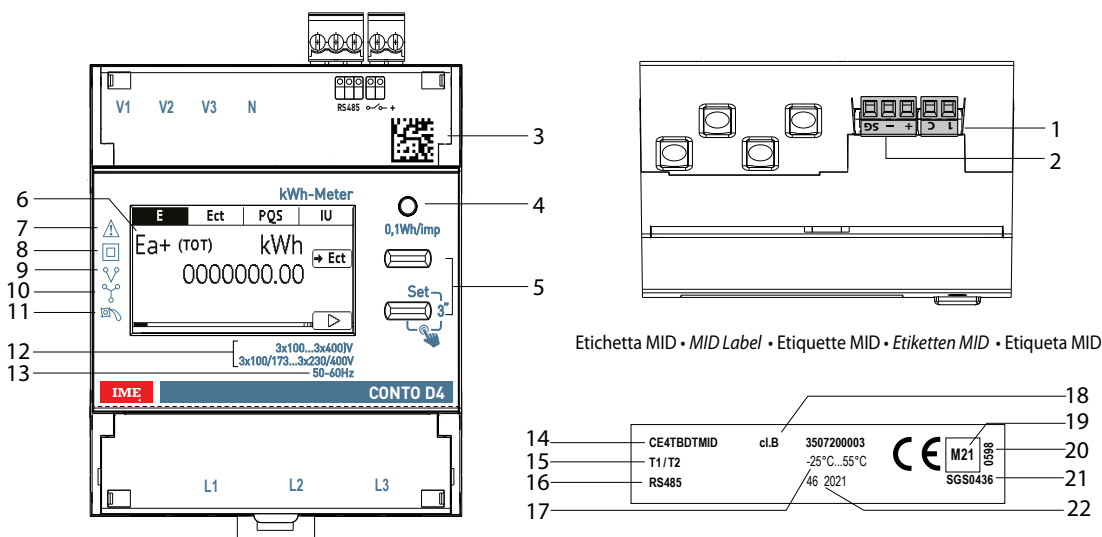

• Presentazione

1. Morsetto d'ingresso per il conteggio dell'energia su doppia tariffa
2. Morsetti di collegamento uscita impulsi o connessione Modbus/Mbus
3. Datamatrix per tracciabilità prodotto
4. LED metrologico
5. Tastiera composta da 2 pulsanti a doppia funzionalità (visualizzazione/configurazione)
6. Display grafico
7. Consultare manuale d'uso prima dell'installazione
8. Doppio isolamento
9. Inserzione su linea trifase 3 fili
10. Inserzione su linea trifase 4 fili
11. Dispositivo antirotazione (antidecremento)
12. Tensione/Corrente di impiego
13. Frequenza di impiego

Etichetta MID

14. Codice articolo
15. Doppia tariffa
16. Uscite
17. Temperatura d'impiego
18. Classe di precisione
19. Anno di approvazione
20. Ente certificatore
21. Numero certificazione
22. Settimana e anno di fabbricazione

• Presentation

1. Input terminal for energy metering on double tariff
2. Pulse output connection terminal or Modbus/Mbus connection
3. Datamatrix for product traceability
4. Metrological LED
5. Keypad made up of 2 double function pushbuttons (display/configurations)
6. Graphic display
7. Consult the user manual before installation
8. Double insulation
9. Connection on 3-wire three-phase line
10. Connection on 4-wire three-phase line
11. Anti-rotation device (anti-decreasing)
12. Operating Voltage/Current
13. Frequency of use

MID Label

14. Product code
15. Double tariff
16. Outputs
17. Working temperature
18. Accuracy class
19. Year of approval
20. Certifying board
21. Certification NUMBER
22. Manufacturing week and year

• Présentation

1. Bornier entrée pour le comptage de l'énergie en double tarif
2. Bornier sortie impulsions ou branchement Modbus/Mbus
3. Datamatrix pour traçabilité produit
4. LED métrologique
5. Clavier constitué de 2 boutons à deux fonctions (visualisation/configuration)
6. Écran graphique
7. Consulter le manuel d'utilisation avant de procéder à l'installation.
8. Double isolation
9. Raccordement sur ligne triphasés 3 fils
10. Raccordement sur ligne triphasés 4 fils
11. Dispositif anti-rotation (anti-diminution)
12. Tension/Courant de fonctionnement
13. Fréquence d'utilisation

Etiquette MID

14. Code du produit
15. Double tarif
16. Sorties
17. Température de fonctionnement
18. Classe de précision
19. Année de certification
20. Organisme de certification
21. Numéro de certification
22. Semaine et année de fabrication

• Presentation

1. Eingangsklemme zum Zählen von Energie im Doppeltarif
2. Anschlussklemmen Impulsausgang oder Ausgang Modbus/Mbus
3. Datamatrix für die Verfolgbarkeit des Produkts
4. Metrologie LED
5. Tastatur bestehend aus 2 Tasten mit Doppelfunktion (Display/Konfiguration)
6. Graphisches Display
7. Bitte lesen das Handbuch bevor den Einbau
8. Doppelisolierung
9. Drehstromleitung 3 Leiter
10. Drehstromleitung 4 Leiter
11. Verdrehssicherung (Anti-Verringerung)
12. Betriebsspannung/ -strom
13. Häufigkeit der Nutzung

Etiketten MID

14. Produktcode
15. Doppeltarif
16. Ausgänge
17. Betriebstemperatur
18. Genauigkeitsklasse
19. Anlegungsjahr
20. Zertifizierungsstelle
21. Zertifizierungsnummer
22. Woche und Herstellungsjahr

• Presentación

1. Borne de entrada para contabilizar la energía en doble tarifa
2. Borne de conexión de la salida de impulsos o Modbus/Mbus
3. Datamatrix para trazabilidad del producto
4. LED metrológico
5. Teclado compuesto por 2 botones con doble función (visualización/configuración)
6. Display gráfico
7. Consultar el manual de uso antes de la instalación
8. Aislamiento doble
9. Inserción en línea trifásica de 3 hilos
10. Inserción en línea trifásica de 4 hilos
11. Dispositivo antirotación (anti decremento)
12. Voltaje/Corriente de funcionamiento
13. Frecuencia de uso

Etiqueta MID

14. Código de artículo
15. Doble tarifa
16. Salidas
17. Temperatura de uso
18. Clase de precisión
19. Año de certificación
20. Organismo de certificación
21. Número de certificación
22. Semana y año de fabricación

• Installazione • Installation • Installation • Installieren • Instalación

• Prescrizioni

- Evitare la vicinanza con sistemi generatori di perturbazioni elettromagnetiche.

• Recommendations

- Avoid proximity to systems which generate electromagnetic interference.

• Recommendations

- Éviter la proximité avec des systèmes générateurs de perturbations électromagnétiques

• Rezepte

- Nähe zu Generatorsystemen vermeiden elektromagnetische Störungen.

• Prescripciones

- Evitar la proximidad con sistemas que generan interferencias electromagnéticas.

• Collegamento

Per la coppia di serraggio massima dei morsetti vedere la tabella

• Connection

For the maximum terminal torque see the table

• Raccordement

Pour le couple de serrage maximal des bornes voir le tableau

• Anschluss

Das maximale Anzugsmoment der Klemmen finden Sie in der Tabell

• Conexión

Para el par de apriete máximo de los bornes, consultar la tabla

U	3x100/173...3x230/400V 3x100...3x400V		CAT III
CE4TB0PCL1 CE4TBDTCL1 CE4TBMTCL1	I	CT/1A - /5A $I_{min} = 0,01A$ $I_n = 5A$ $I_{max} = 6A$	
	cl.	cl.1 Wh (EN 62053-21) cl.2 varh (EN 62053-23)	
CE4TB0PMID CE4TBDTMID CE4TBMTMID	I	CT/5A $I_{min} = 0,05A$ $I_n = 5A$ $I_{max} = 6A$	
	cl.	cl.B Wh (EN 50470-1,3) cl.2 varh (EN 62053-23)	
	0,1 Wh/imp		
COM		RS485 Modbus	Mbus
 L1-L2-L3 V1-V2-V3		11 mm MAX 1 x 10 mm ²	Recommended torque 1,6 to 2Nm COMBI PZ2
		1 x 10 mm ²	
		1 x 16 mm ²	
 1 C RS485 Mbus		8 mm MAX 1 x 1 mm ²	Recommended torque 0,2Nm 0,5 x 2,5mm
		1 x 1 mm ²	
		1 x 1,5 mm ²	
	(-25°C) - (55°C)		

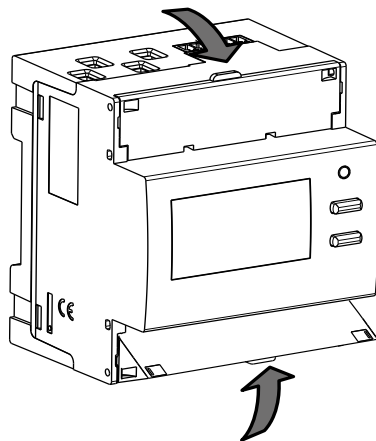

• Alimentazione ausiliaria

derivata dalle prese di tensione (Autoalimentato)

• Auxiliary supply

derived from the voltage terminals (Self-supplied)

• Alimentation auxiliarire

derivée depuis par les prises de tension (Auto-alimentée)

• Hilfsversorgung

abgeleitet von den Spannungsanschlüssen (Selbstversorgung)

• Alimentación auxiliar

derivada de la toma de presión (Autoalimentado)

• Installazione • Installation • Installation • Installieren • Instalación

- Marcatura morsettiera e combinazione schemi
- Terminal board marking and diagram combination
- Marquage borniers et combinaison schémas:
- Markierung der Klemmleisten und Kombination der Anschlussbilder
- Marcado de regletas y combinación de esquemas

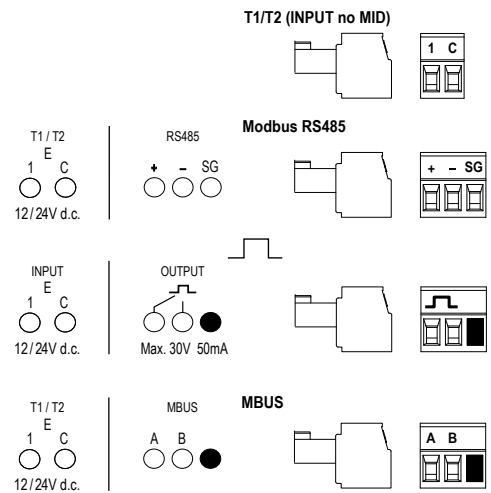

- Schema di collegamento per doppia tariffa • *Wiring diagram for double tariff*
- Schéma de raccordement double tarif • *Schaltplan für Doppeltarif*
- Esquema de conexión para doble tarifa

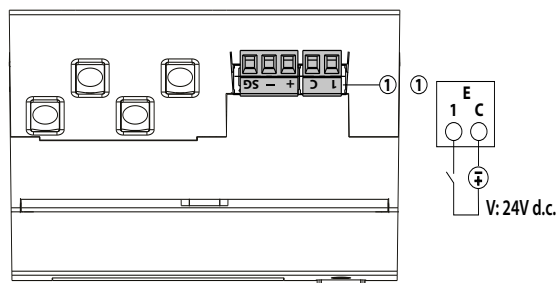

- Collegamento dell'ingresso
- Input connection
- Connexion de l'entrée
- Eingangsverbindung
- Conexión de la entrada

- Nei cablaggi rispettare scrupolosamente lo schema di inserzione; una inesattezza nei collegamenti può pregiudicare il corretto funzionamento o causare danni allo strumento.
- During wiring carefully comply with the connection diagram; a connection error may affect proper operation, or cause damage to the device.
- Veuillez respecter scrupuleusement le schéma de connexion; une erreur de connexion peut nuire au bon fonctionnement, ou causer des dommages à l'appareil.
- Beachten Sie bei der Verdrahtung unbedingt das Anschlusschema; Ungenauigkeiten in den Anschlüssen können zu Fehlbedienungen oder Schäden am Gerät führen.
- En los cableados, se ha de respetar rigurosamente el esquema de inserción; si las conexiones no son precisas, se puede perjudicar el funcionamiento correcto o causar daños al instrumento.

• **Installazione • Installation • Installation • Installieren • Instalación**

- **Schema di collegamento • Wiring diagram • Schéma de câblage • Anschlussbilder**
- **Esquema de conexión**

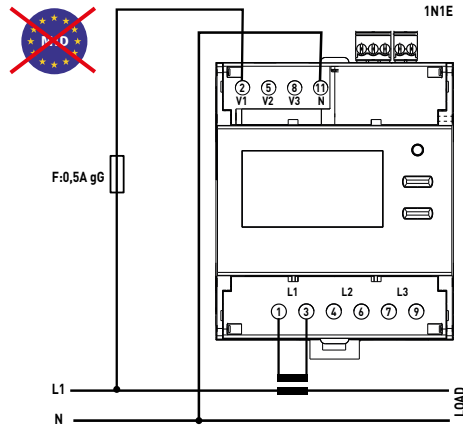

- **Inserzione su VT**
- **Connection on VT**
- **Connexion sur VT**
- **Der Anschluss an VT**
- **Conexión en VT**

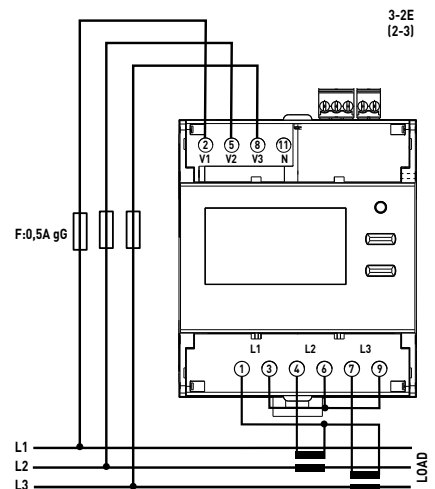
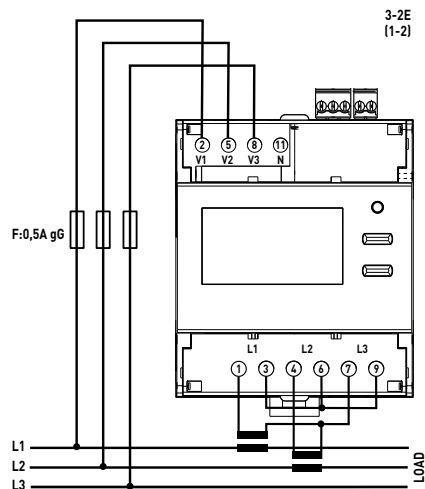
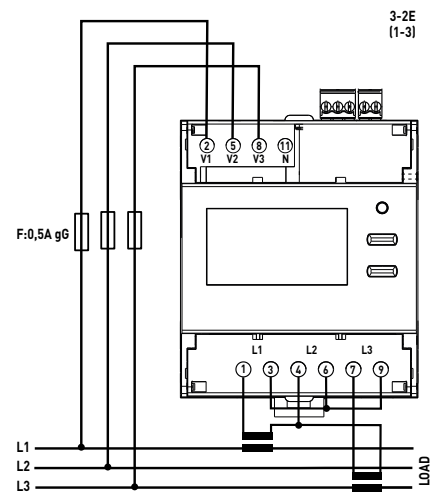
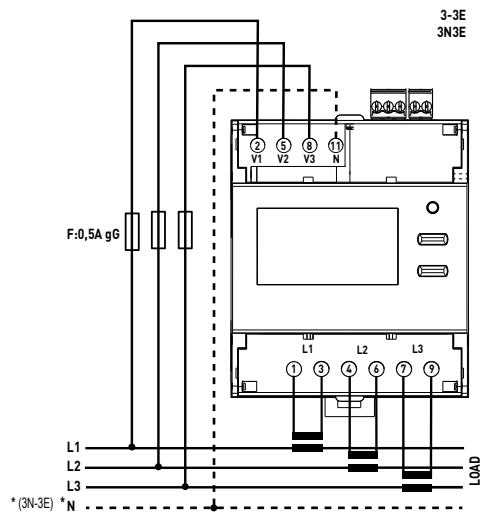
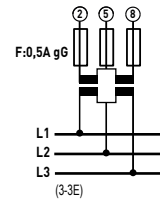
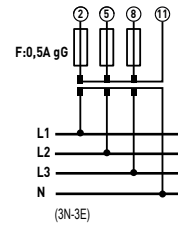

Il collegamento dei TA verso terra dipende dalle normative in vigore nel proprio Paese
 The connection of the CTs to earth depends on the regulations in force in your country
 La connexion des TC à la terre dépend de la réglementation en vigueur dans votre pays
 Der Anschluss der Stromwandler an die Erde hängt von den in Ihrem Land geltenden Vorschriften ab
 La conexión de los TC a tierra depende de la normativa vigente en su país.

• **Installazione • Installation • Installation • Installieren • Instalación**

- **Schema di collegamento RS485 • RS485 wiring diagram • Schéma de branchement RS485**
- **Anschlussbilder RS485 • Esquema de conexión RS485**

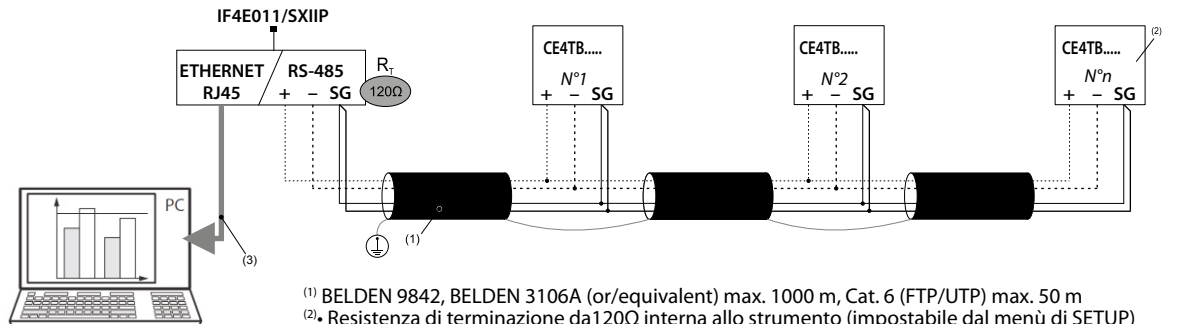

- (1) BELDEN 9842, BELDEN 3106A (or/equivalent) max. 1000 m, Cat. 6 (FTP/UTP) max. 50 m
 (2) Resistenza di terminazione da 120Ω interna allo strumento (impostabile dal menù di SETUP)
 • 120Ω terminating resistor inside the instrument (it can be set in the SETUP menu)
 • Résistance de terminaison de 120 Ω intégrée à l'instrument (réglable dans le menu de RÉGLAGE)
 • 120Ω Abschlusswiderstand intern im Gerät (einstellbar über das SETUP-Menü)
 • Resistencia de terminación de 120Ω interna en el instrumento (ajustable en el menù SETUP)
 (3) Ethernet: Cat. 6 (FTP/UTP)

- **Schema di collegamento RS485 Modbus con Mini Web Server**
- **RS485 Modbus wiring diagram with Mini web Server**
- **Schéma de branchement RS485 Modbus avec Mini Web Server**
- **Anschlussbilder RS485 Modbus Mini Web Server**
- **Esquema de conexión RS485 Modbus con Mini Web Server**

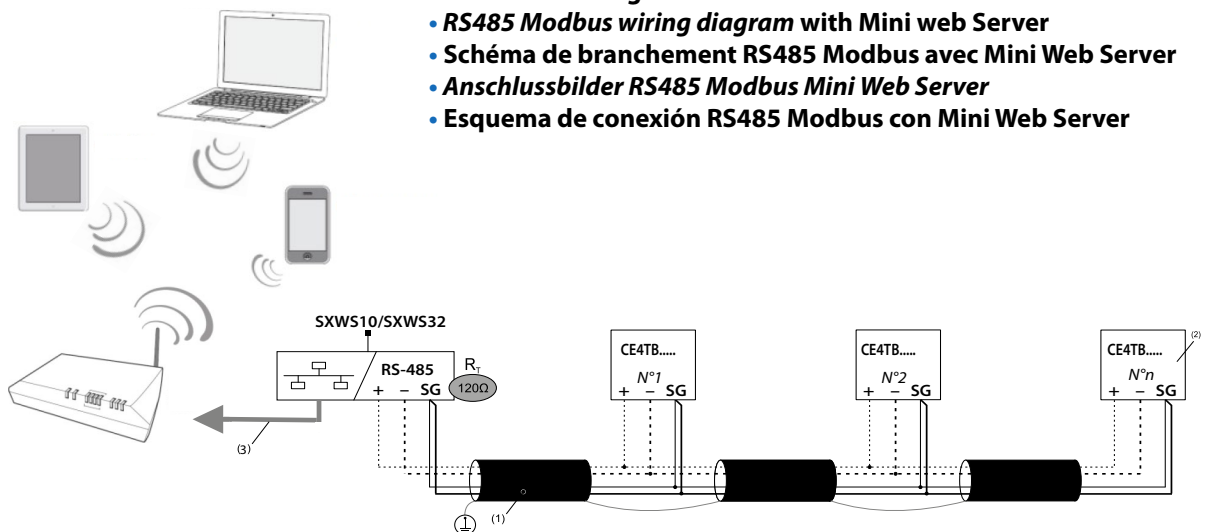

- **Schema di collegamento Mbus**
- **Mbus Modbus wiring diagram**
- **Schéma de branchement Mbus**
- **Anschlussbilder Mbus**
- **Esquema de conexión Mbus**

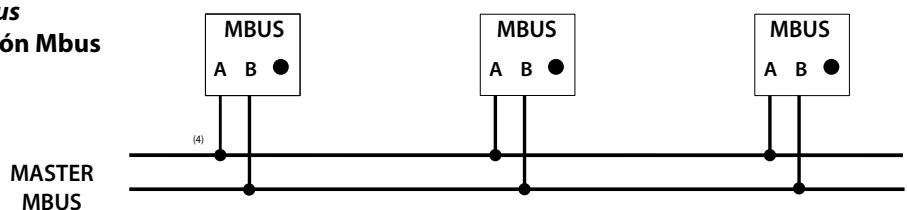

- (4) Collegamenti non polarizzati. Un cavo telefonico standard a due fili (JYStY N°2*0.8 mm)
 Non-polarized connections. A two-wire standard telephone cable (JYStY N°2*0.8 mm)
 Connexions non polarisées. Un câble téléphonique standard à deux fils (JYStY N°2*0.8 mm)
 Nicht polarisierte Verbindungen. Ein zweidrahtiges Standardtelefonkabel (JYStY N°2*0.8 mm)
 Conexiones no polarizadas. Un cable telefónico estándar de dos hilos (JYStY N°2*0.8 mm)

• Utilizzo • Use • Utilisation • Verwendung • Utilización

• Navigazione pagine di visualizzazione

Il dispositivo è dotato di un display grafico su cui è riportata la funzione eseguita dal tasto corrispondente ed è dipendente dalla pagina visualizzata.

• Navigation display pages

The device is equipped with a graphic display showing the function performed by the corresponding key and is dependent on the page displayed.

• Pages d'affichage de navigation

L'appareil est équipé d'un écran graphique indiquant la fonction remplie par la touche correspondante et est dépendant de la page affichée

• Durchsuchen von Anzeigeseiten

Das Gerät ist mit einem Grafikdisplay ausgestattet, das die von der entsprechenden Taste ausgeführte Funktion anzeigt und ist abhängig von der angezeigten Seite

• Navegando por páginas de visualización

El dispositivo está equipado con una pantalla gráfica que muestra la función realizada por la tecla correspondiente y está depende de la página mostrada

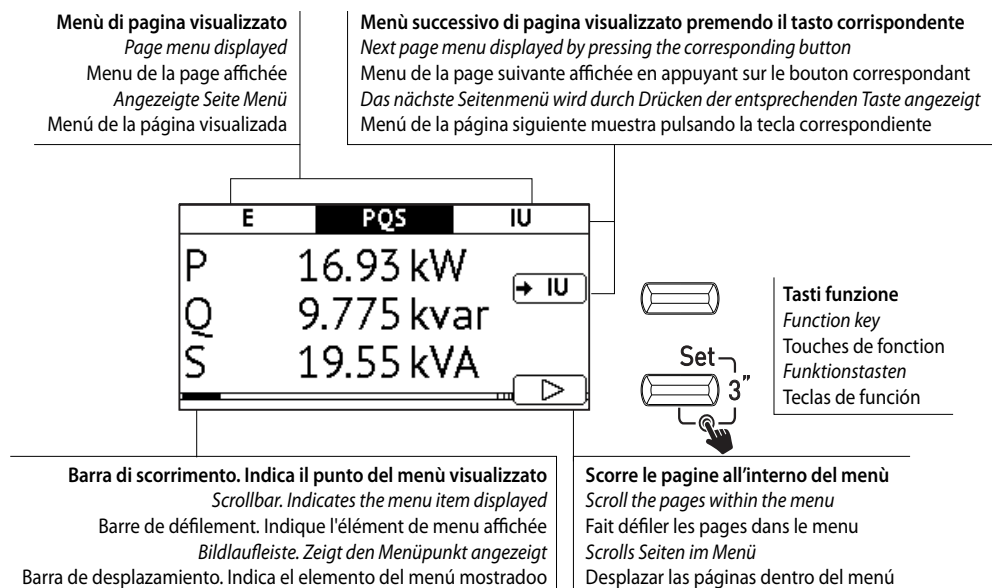

Energia diretta
 Direct energy
 Energie direct
 Direkte Energie
 Energía directa

Energia Indiretta
 Indirect energy
 Energie indirect
 Indirekte Energie
 Energía indirecta

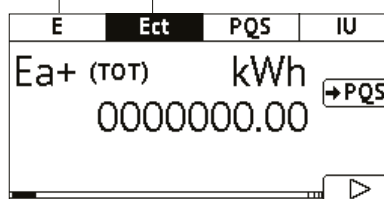

• Utilizzo • Use • Utilisation • Verwendung • Utilización

• Energie direkte • Direct energies • Energies directes • Direkte energie • Energias directas

CE4TBDTCL1
CE4TBMTCCL1
CE4TB0PCL1

Su tutti i modelli
On all codes
Sur tous les codes
Auf allen Codes
En todos los codigos

The screenshots show the following data:

- Screen 1:** Total positive active energy (Ea+ (TOT) kWh), Total negative active energy (Ea- (TOT) kWh), Total positive reactive energy (Er+ (TOT) kvarh), Total negative reactive energy (Er- (TOT) kvarh).
- Screen 2:** Total positive active energy T1/T2 (Ea+ kWh), Total negative active energy T1/T2 (Ea- kWh), Total positive reactive energy T1/T2 (Er+ kvarh), Total negative reactive energy T1/T2 (Er- kvarh).
- Screen 3:** Partial positive active energy (Ea+ (Par) kWh), Partial negative active energy (Ea- (Par) kWh), Partial positive reactive energy (Er+ (Par) kvarh), Partial negative reactive energy (Er- (Par) kvarh).
- Screen 4:** Pulse counter (Pulse In Wh).

** CE4TBDTCL1
 ** CE4TBMTCCL1

Su tutti i modelli
On all codes
Sur tous les codes
Auf allen Codes
En todos los codigos

CE4TB0PCL1
 * CE4TBDTCL1
 * CE4TBMTCCL1

Energia attiva totale positiva

Total positive active energy
Energie active positive totale
Total positive Wirkenergie
Energia activa positiva total

Energia attiva totale negativa

Total negative active energy
Energie active négative totale
Total negative Wirkenergie
Energia activa negativa total

Energia reattiva totale positiva

Total positive reactive energy
Energie réactive positive totale
Total positive Blindenergie
Energia reactiva positiva total

Energia reattiva totale negativa

Total negative reactive energy
Energie réactive négative totale
Total negative Blindenergie
Energia reactiva negativa total

Energia attiva totale positiva T1/ T2

Total positive active energy T1/T2
Energie active positive totale T1/T2
Total positive Wirkenergie T1/T2
Energia activa positiva total T1/T2

Energia attiva totale negativa T1/ T2

Total negative active energy T1/T2
Energie active négative totale T1/T2
Total negative Wirkenergie T1/T2
Energia activa negativa total T1/T2

Energia reattiva totale positiva T1/ T2

Total positive reactive energy T1/T2
Energie réactive positive totale T1/T2
Total positive Blindenergie T1/T2
Energia reactiva positiva total T1/T2

Energia reattiva totale negativa T1/ T2

Total negative reactive energy T1/T2
Energie réactive négative totale T1/T2
Total negative Blindenergie T1/T2
Energia reactiva negativa total T1/T2

Energia attiva parziale positiva

Partial positive active energy
Energie active positive partielle
Positive teilweise Wirkenergie
Energia activa parcial positiva

Energia attiva parziale negativa

Partial negative active energy
Energie active partielle negative
Negative teilweise Wirkenergie
Energia activa parcial negativa

Energia reattiva parziale positiva

Positive partial reactive energy
Energie réactive partielle positive
Positive teilweise Blindenergie
Energia reactiva parcial positiva

Energia reattiva parziale negativa

Partial negative reactive energy
Energie réactive partielle négative
Negative teilweise Blindenergie
Energia reactiva parcial negativa

Contatore di impulsi

Pulse counter
Compteur d'impulsions
Impulszähler
Contador de pulsos

• Utilizzo • Use • Utilisation • Verwendung • Utilización

- Energie dirette/indirette • Direct/indirect energies • Energies directes/indirectes
- Direkte/indirekte energien • Energías directas/Indirectas

CE4TBDTMD
CE4TBM TMID
CE4TB0PMID



Su tutti i modelli
On all codes
Sur tous les codes
Auf allen Codes
En todos los codigos

CE4TBDTMD
CE4TBM TMID

Su tutti i modelli
On all codes
Sur tous les codes
Auf allen Codes
En todos los codigos

CE4TB0PMID

	E	Ect	PQS	IU
Modbus / Mbus	Ea+ (TOT)		kWh	→ Ect
			0000000.00	
	Ea- (TOT)		kWh	→ Ect
			0000000.00	
Modbus / Mbus	Er+ (TOT)		kvarh	→ Ect
			0000000.00	
	Er- (TOT)		kvarh	→ Ect
			0000000.00	
Modbus / Mbus	Ea+		kWh	→ Ect
	T ₁ ON		0000000.00	
	T ₂		0000000.00	
	Ea-		kWh	→ Ect
	T ₁ ON		0000000.00	
	T ₂		0000000.00	
	Er+		kvarh	→ Ect
	T ₁ ON		0000000.00	
T ₂		0000000.00		
Modbus / Mbus	Er-		kvarh	→ Ect
	T ₁ ON		0000000.00	
	T ₂		0000000.00	
	Modbus / Mbus	Ea+ (Par)		kWh
			0000000.00	3" Rst
Ea- (Par)			kWh	→ Ect
			0000000.00	3" Rst
Modbus / Mbus	Er+ (Par)		kvarh	→ Ect
			0000000.00	3" Rst
	Er- (Par)		kvarh	→ Ect
			0000000.00	3" Rst
Modbus / Mbus	Pulse In		Wh	→ Ect
			0000000.00	3" Rst

Energia attiva totale positiva

Total positive active energy
Energie active positive totale
Total positive Wirkenergie
Energia activa positiva total

Energia attiva totale negativa

Total negative active energy
Energie active négative totale
Total negative Wirkenergie
Energia activa negativa total

Energia reattiva totale positiva

Total positive reactive energy
Energie réactive positive totale
Total positive Blindenergie
Energia reactiva positiva total

Energia reattiva totale negativa

Total negative reactive energy
Energie réactive négative totale
Total negative Blindenergie
Energia reactiva negativa total

Energia attiva totale positiva T1/ T2

Total positive active energy T1/T2
Energie active positive totale T1/T2
Total positive Wirkenergie T1/T2
Energia activa positiva total T1/T2

Energia attiva totale negativa T1/ T2

Total negative active energy T1/T2
Energie active négative totale T1/T2
Total negative Wirkenergie T1/T2
Energia activa negativa total T1/T2

Energia reattiva totale positiva T1/ T2

Total positive reactive energy T1/T2
Energie réactive positive totale T1/T2
Total positive Blindenergie T1/T2
Energia reactiva positiva total T1/T2

Energia reattiva totale negativa T1/ T2

Total negative reactive energy T1/T2
Energie réactive négative totale T1/T2
Total negative Blindenergie T1/T2
Energia reactiva negativa total T1/T2

Energia attiva parziale positiva

Partial positive active energy
Energie active positive partielle
Positive teilweise Wirkenergie
Energia activa parcial positiva

Energia attiva parziale negativa

Positive partial active energy
Energie active partielle positive
Positive teilweise Wirkenergie
Energia activa parcial positiva

Energia reattiva parziale positiva

Positive partial reactive energy
Energie réactive partielle positive
Positive teilweise Blindenergie
Energia reactiva parcial positiva

Energia reattiva parziale negativa

Partial negative reactive energy
Energie réactive partielle négative
Negative teilweise Blindenergie
Energia reactiva parcial negativa

Contatore di impulsi

Pulse counter
Compteur d'impulsions
Impulszähler
Contador de pulsos

• **Utilizzo • Use • Utilisation • Verwendung • Utilización**

• **Potenze • Powers • Puissance • Leistung • Potestades**

CE4TBDTCL1
CE4TBMTCCL1
CE4TB0PCL1

Su tutti i modelli
On all codes
Sur tous les codes
Auf allen Codes
En todos los codigos

Ect	PQS	IU
P	0.000 kW	→ IU
Q	0.000 kvar	
S	0.000 kVA	
P ₁	0.000 kW	→ IU
P ₂	0.000 kW	
P ₃	0.000 kW	
Q ₁	0.000 kvar	→ IU
Q ₂	0.000 kvar	
Q ₃	0.000 kvar	
S ₁	0.000 kVA	→ IU
S ₂	0.000 kVA	
S ₃	0.000 kVA	
PF	0.000	→ IU
MD	5 min 0.000 kW	→ IU
PMD	0.000 kW	→ IU

** CE4TBDTCL1
** CE4TBMTCCL1

CE4TB0PCL1
* CE4TBDTCL1
* CE4TBMTCCL1

Potenze trifase

Three-phase powers
Puissance triphasés
Dreiphasige Leistungen
Potencias trifásicas

Potenze attive di fase (solo 3N3E)

Phase active power (only 3N3E)
Puissance active par phase (seul 3N3E)
Wirkleistungen je Phase (nur 3N3E)
Fases de potencias activas (únicamente 3N3E)

Potenze reattive di fase (solo 3N3E)

Phase reactive power (only 3N3E)
Puissance reactive par phase (seul 3N3E)
Blindleistungen je Phase (nur 3N3E)
Fases de potencias reactivas (únicamente 3N3E)

Potenze apparenti di fase (solo 3N3E)

Phase apparent power (only 3N3E)
Puissance apparente par phase (seul 3N3E)
Scheinleistungen je Phase (nur 3N3E)
Fases de potencia aparentes (únicamente 3N3E)

Fattore di potenza trifase (Ind./Cap.)

Three-phase power factor (Ind./Cap.)
Facteur de puissance triphasés (Ind./Cap.)
Dreiphasige Leistungsfaktor (Ind./Kap.)
Factor de potencia trifásicas (Ind./Cap.)

Potenza media / tempo integrazione

Power demand / tempo integrazione
Puissance moyenne / temps d'intégration
Mittlere Leistung / Integrationszeit
Potencia media / tiempo de integración

Picco di potenza media T1

Power Max. demand T1
Pointe de puissance moyenne T1
Mittlere Leistungsspitze T1
Pico de potencia promedio T1

Picco di potenza media T2

Power Max. demand T2
Pointe de puissance moyenne T2
Mittlere Leistungsspitze T2
Pico de potencia promedio T2

Picco di potenza media

Power Max. demand
Pointe de puissance moyenne
Mittlere Leistungsspitze
Pico de potencia promedio

Nota * Pagina visualizzabile solo se la configurazione ingresso è stata programmata come "Input mode Pulse"

** Pagina visualizzabile solo se la configurazione ingresso è stata programmata come "Input mode Tariff"

Nota * Page viewable only if the input configuration has been programmed as "Input mode Pulse"

** Page viewable only if the input configuration has been programmed as "Input mode Tariff"

Nota * Page visible uniquement si la configuration d'entrée a été programmée comme "Input mode Pulse"

** Page visible uniquement si la configuration d'entrée a été programmée comme "Input mode Tariff"

Nota * Seite nur sichtbar, wenn die Eingangskonfiguration als "Input mode Pulse"

** Seite nur sichtbar, wenn die Eingangskonfiguration als "Input mode Tariff"

Nota * Página visible solo si la configuración de entrada se ha programado como "Input mode Pulse"

** Página visible solo si la configuración de entrada se ha programado como "Input mode Tariff"

• Utilizzo • Use • Utilisation • Verwendung • Utilización

• Potenze • Powers • Puissance • Leistung • Potestades

CE4TBDTMID
CE4TBMTMID
CE4TB0PMID



Su tutti i modelli
On all codes
Sur tous les codes
Auf allen Codes
En todos los codigos

	E	Ect	PQS	IU
P				0.000 kW
Q				0.000 kvar
S				0.000 kVA
P ₁				0.000 kW
P ₂				0.000 kW
P ₃				0.000 kW
Q ₁				0.000 kvar
Q ₂				0.000 kvar
Q ₃				0.000 kvar
S ₁				0.000 kVA
S ₂				0.000 kVA
S ₃				0.000 kVA
PF				0.000
MD				5 min 0.000 kW

	E	Ect	PQS	IU
PF				0.000

Potenze trifase

Three-phase powers
Puissance triphasés
Dreiphasige Leistungen
Potencias trifásicas

Potenze attive di fase (solo 3N3E)

Phase active power (only 3N3E)
Puissance active par phase (seul 3N3E)
Wirkleistungen je Phase (nur 3N3E)
Fases de potencias activas (únicamente 3N3E)

Potenze reattive di fase (solo 3N3E)

Phase reactive power (only 3N3E)
Puissance reactive par phase (seul 3N3E)
Blindleistungen je Phase (nur 3N3E)
Fases de potencias reactivas (únicamente 3N3E)

Potenze apparenti di fase (solo 3N3E)

Phase apparent power (only 3N3E)
Puissance apparente par phase (seul 3N3E)
Scheinleistungen je Phase (nur 3N3E)
Fases de potencia aparentes (únicamente 3N3E)

Fattore di potenza trifase (Ind./Cap.)

Three-phase power factor (Ind./Cap.)
Facteur de puissance triphasés (Ind./Cap.)
Dreiphasige Leistungsfaktor (Ind./Kap.)
Factor de potencia trifásicas (Ind./Cap.)

Potenza media / tempo integrazione

Power demand / tempo integrazione
Puissance moyenne / temps d'intégration
Mittlere Leistung / Integrationszeit
Potencia media / tiempo de integración

CE4TBDTMID
CE4TBMTMID

	E	Ect	PQS	IU
PMD				0.000 kW
T ₁				0.000 kW
T ₂				0.000 kW

Picco di potenza media T1

Power Max. demand T1
Pointe de puissance moyenne T1
Mittlere Leistungsspitze T1
Pico de potencia promedio T1

Picco di potenza media T2

Power Max. demand T2
Pointe de puissance moyenne T2
Mittlere Leistungsspitze T2
Pico de potencia promedio T2

Picco di potenza media

Power Max. demand
Pointe de puissance moyenne
Mittlere Leistungsspitze
Pico de potencia promedio

CE4TB0PMID

	E	Ect	PQS	IU
PMD				0.000 kW

- Azzeramento
- Reset
- Remise à zéro
- Rücksetzen
- Volver a cero

Nota: L'azzeramento è possibile solo nelle pagine dove appare la dicitura **3" Rst**

Nota: Reset is possible only in the pages where **3" Rst** appears

Nota: Mise à zéro est possible que sur les pages où apparaît le libellé **3" Rst**

Nota: Ein Zurücksetzen ist nur auf den Seiten möglich, auf denen **3" Rst** zuerst angezeigt wird

Nota: Reducción a cero es posible sólo en las páginas en las que aparece el texto **Rst 3"**

	E	PQS	IU
Hours			h.m
TOT			19999.53

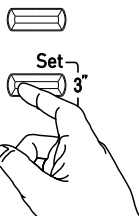

x1
3" sec.
Reset

	E	PQS	IU
Hours			h.m
TOT			00000.00

• Utilizzo • Use • Utilisation • Verwendung • Utilización

- Tensioni e correnti • Voltages and currents • Tensions et courants • Spannungen und Ströme
- Tensiones y corrientes

CE4TBDTCL1
CE4TBMTCCL1
CE4TB0PCL1

Su tutti i modelli
On all codes
Sur tous les codes
Auf allen Codes
En todos los codigos

Ect	PQS	IU
U ₁	230.0V	→ Ect
I ₁	0.000A	
▶		
Ect	PQS	IU
U ₁	230.0V	→ Ect
U ₂	230.0V	
U ₃	230.0V	
▶		
Ect	PQS	IU
U ₁₂	400.0V	→ Ect
U ₂₃	400.0V	
U ₃₁	400.0V	
▶		
Ect	PQS	IU
I ₁	0.000A	→ Ect
I ₂	0.000A	
I ₃	0.000A	
▶		
Ect	PQS	IU
f	50.01 Hz	→ Ect
▶		
Ect	PQS	IU
Φ(U ₁ -U ₂)	0.0°	→ Ect
Φ(U ₂ -U ₃)	0.0°	
Φ(U ₃ -U ₁)	0.0°	
▶		
Ect	PQS	IU
Φ(U ₁₂ -U ₂₃)	0.0°	→ Ect
Φ(U ₂₃ -U ₃₁)	0.0°	
Φ(U ₃₁ -U ₁₂)	0.0°	
▶		
Ect	PQS	IU
Φ(I ₁ -I ₂)	0.0°	→ Ect
Φ(I ₂ -I ₃)	0.0°	
Φ(I ₃ -I ₁)	0.0°	
▶		
Ect	PQS	IU
Φ(U ₁ -I ₁)	0.0°	→ Ect
Φ(U ₂ -I ₂)	0.0°	
Φ(U ₃ -I ₃)	0.0°	
▶		
Ect	PQS	IU
Φ(U ₁ -I ₁)	0.0°	→ Ect
▶		
Ect	PQS	IU
Hours	h.m	→ Ect
TOT	00000.00	
▶		
3" Rst		

Mbus/Modbus	Ect	PQS	IU
Hours	h.m		→ Ect
T ₁	00000.00		
T ₂	00000.00		

** CE4TBDTCL1
** CE4TBMTCCL1

Tensione e corrente di fase (solo 1N1E)

Phase voltage and current (only 1N1E)
Tension et courant simple (seul 1N1E)
Phasenspannung und -strom (nur 1N1E)
Tensione y corriente de fase (únicamente 1N1E)

Tensioni di fase (solo 3N3E)

Phase voltages (only 3N3E)
Tension simple (seul 3N3E)
Phasenspannungen (nur 3N3E)
Tensiones de fase (únicamente 3N3E)

Tensioni concatenate (solo 3N3E; 3-3E; 3-2E)

Linked voltages (only 3N3E; 3-3E; 3-2E)
Tensions composée (seul 3N3E; 3-3E; 3-2E)
Verketteten Spannungen (nur 3N3E; 3-3E; 3-2E)
Tensiones concatenadas (únicamente 3N3E; 3-3E; 3-2E)

Correnti di fase (solo 3N3E; 3-3E; 3-2E)

Phase currents (only 3N3E; 3-3E; 3-2E)
Courant par phase (seul 3N3E; 3-3E; 3-2E)
Phasenströme (nur 3N3E; 3-3E; 3-2E)
Corrientes de fase (únicamente 3N3E; 3-3E; 3-2E)

Frequenza di rete

Network frequency
Fréquence du réseau
Netzwerkfrequenz
Frecuencia de red

Sfasamento fra le tensioni di fase (solo 3N3E)

Phase shift between the phase voltages (only 3N3E)
Décalage de phase entre les tensions de phase (seul 3N3E)
Phasenverschiebung zwischen den Phasenspannungen (nur 3N3E)
Desplazamiento de fase entre las tensiones de fase (únicamente 3N3E)

Sfasamento fra le tensioni di fase (solo 3-3E; 3-2E)

Phase shift between the phase voltages (only 3-3E; 3-2E)
Décalage de phase entre les tensions de phase (seul 3-3E; 3-2E)
Phasenverschiebung zwischen den Phasenspannungen (nur 3-3E; 3-2E)
Desplazamiento de fase entre las tensiones de fase (únicamente 3-3E; 3-2E)

Sfasamento fra le correnti di fase (solo 3N3E; 3-3E; 3-2E)

Phase shift between the phase currents (only 3N3E; 3-3E; 3-2E)
Décalage de phase entre les courants de phase (seul 3N3E; 3-3E; 3-2E)
Phasenverschiebung zwischen den Phasenströmen (nur 3N3E; 3-3E; 3-2E)
Desplazamiento de fase entre las corrientes de fase (únicamente 3N3E; 3-3E; 3-2E)

Sfasamento fra tensioni e correnti (solo 3N3E; 3-3E; 3-2E)

Phase shift between voltages and currents (only 3N3E; 3-3E; 3-2E)
Déphasage entre tensions et courants (seul 3N3E; 3-3E; 3-2E)
Phasenverschiebung zwischen Spannungen und Strömen (nur 3N3E; 3-3E; 3-2E)
Desplazamiento de fase entre tensiones y corrientes (únicamente 3N3E; 3-3E; 3-2E)

Sfasamento fra tensioni e correnti (solo 1N1E)

Phase shift between voltages and currents (only 1N1E)
Déphasage entre tensions et courants (seul 1N1E)
Phasenverschiebung zwischen Spannungen und Strömen (nur 1N1E)
Desplazamiento de fase entre tensiones y corrientes (únicamente 1N1E)

Contatore orario

Hour counter
Compteur d'heures
Zeitähler
Contador de horas

Contatore orario T1/ T2

Hour counter T1/ T2
Compteur d'heures T1/ T2
Zeitähler T1/ T2
Contador de horas T1/ T2

• Utilizzo • Use • Utilisation • Verwendung • Utilización

• Tensioni e correnti • Voltages and currents • Tensions et courants • Spannungen und Ströme
• Tensiones y corrientes

CE4TBDTMID
CE4TBMTMID
CE4TB0PMID



Su tutti i modelli
On all codes
Sur tous les codes
Auf allen Codes
En todos los codigos

	E	Ect	PQS	IU
U ₁	230.0V			→ E
U ₂	230.0V			→ E
U ₃	230.0V			→ E
U ₁₂	400.0V			→ E
U ₂₃	400.0V			→ E
U ₃₁	400.0V			→ E
I ₁	0.000 A			→ E
I ₂	0.000 A			→ E
I ₃	0.000 A			→ E
f	50.00 Hz			→ E
Φ(U ₁ -U ₂)	0.0°			→ E
Φ(U ₂ -U ₃)	0.0°			→ E
Φ(U ₃ -U ₁)	0.0°			→ E
Φ(U ₁₂ -U ₂₃)	0.0°			→ E
Φ(U ₂₃ -U ₃₁)	0.0°			→ E
Φ(U ₃₁ -U ₁₂)	0.0°			→ E
Φ(I ₁ -I ₂)	0.0°			→ E
Φ(I ₂ -I ₃)	0.0°			→ E
Φ(I ₃ -I ₁)	0.0°			→ E
Φ(U ₁ -I ₁)	0.0°			→ E
Φ(U ₂ -I ₂)	0.0°			→ E
Φ(U ₃ -I ₃)	0.0°			→ E
Hours	h.m			→ E
TOT	00000.00			→ E
Hours	h.m			→ E
T ₁ ON	00000.00			→ E
T ₂	00000.00			→ E

Tensioni di fase (solo 3N3E)

Phase voltages (only 3N3E)
Tension simple (seul 3N3E)
Phasenspannungen (nur 3N3E)
Tensiones de fase (únicamente 3N3E)

Tensioni concatenate (solo 3N3E; 3-3E; 3-2E)

Linked voltages (only 3N3E; 3-3E; 3-2E)
Tensions composée (seul 3N3E; 3-3E; 3-2E)
Verketteten Spannungen (nur 3N3E; 3-3E; 3-2E)
Tensiones concatenadas (únicamente 3N3E; 3-3E; 3-2E)

Correnti di fase (solo 3N3E; 3-3E; 3-2E)

Phase currents (only 3N3E; 3-3E; 3-2E)
Courant par phase (seul 3N3E; 3-3E; 3-2E)
Phasenströme (nur 3N3E; 3-3E; 3-2E)
Corrientes de fase (únicamente 3N3E; 3-3E; 3-2E)

Frequenza di rete

Network frequency
Fréquence du réseau
Netzwerkfrequenz
Frecuencia de red

Sfasamento fra le tensioni di fase (solo 3N3E)

Phase shift between the phase voltages (only 3N3E)
Décalage de phase entre les tensions de phase (seul 3N3E)
Phasenverschiebung zwischen den Phasenspannungen (nur 3N3E)
Desplazamiento de fase entre las tensiones de fase (únicamente 3N3E)

Sfasamento fra le tensioni di fase (solo 3-3E; 3-2E)

Phase shift between the phase voltages (only 3-3E; 3-2E)
Décalage de phase entre les tensions de phase (seul 3-3E; 3-2E)
Phasenverschiebung zwischen den Phasenspannungen (nur 3-3E; 3-2E)
Desplazamiento de fase entre las tensiones de fase (únicamente 3-3E; 3-2E)

Sfasamento fra le correnti di fase (solo 3N3E; 3-3E; 3-2E)

Phase shift between the phase currents (only 3N3E; 3-3E; 3-2E)
Décalage de phase entre les courants de phase (seul 3N3E; 3-3E; 3-2E)
Phasenverschiebung zwischen den Phasenströmen (nur 3N3E; 3-3E; 3-2E)
Desplazamiento de fase entre las corrientes de fase (únicamente 3N3E; 3-3E; 3-2E)

Sfasamento fra tensioni e correnti (solo 3N3E; 3-3E; 3-2E)

Phase shift between voltages and currents (only 3N3E; 3-3E; 3-2E)
Déphasage entre tensions et courants (seul 3N3E; 3-3E; 3-2E)
Phasenverschiebung zwischen Spannungen und Strömen (nur 3N3E; 3-3E; 3-2E)
Desplazamiento de fase entre tensiones y corrientes (únicamente 3N3E; 3-3E; 3-2E)

Contatore orario

Hour counter
Compteur d'heures
Zeitähler
Contador de horas

Contatore orario T1/T2

Hour counter T1/T2
Compteur d'heures T1/T2
Zeitähler T1/T2
Contador de horas T1/T2

• Programmazione • Programming • Programmation • Programmierung
• Programación

Modbus
CE4TBDTCL1
CE4TBDTMD

MID / no MID	Address 001	Indirizzo RS485 RS485 address Adresse RS485 Dirección RS485
	Baudrate 19.2 kbit/s	Velocità di comunicazione Communication speed Vitesse de communication Kommunikationsgeschwindigkeit Velocidad de comunicación
	Parity Even	Bit di parità Parity bit Bit de parité Paritätsbit Bit de paridad
	RX time 15 ms	Tempo di risposta a interrogazione Required response time to request Temps de réponse à la requête Antwortzeit auf Abfrage Tiempo de respuesta a la consulta
	Termination None	Resistenza di terminazione Termination resistance Résistance de terminaison Kündigungswiderstand Resistencia de terminación
	Protocol Standard	Tipo di protocollo Protocol type Type de protocole Protokolltyp Tipo de protocolo
	Int. time (MD) 15 Minutes	Tempo di integrazione potenza media Tempo di integrazione potenza media Temps d'intégration moyen Durchschnittliche Power-Integrationszeit Tiempo medio de integración de potencia
	Run hours thr 00.00%	Avvio conteggio Start counting Commencez comptage Beginnen Sie zu zählen Empezar a contar
	KTA 0001	Rapporto TA esterni External CT ratio Rapport des TC externes Verhältnis des externen CT Relación de CT externa
	KTV 001.00	Rapporto TV esterni External VT ratio Rapport des TP externes Verhältnis des externen VT Relación de VT externa
	Wiring 3n-3E	Tipo di connessione Connection type Type de connexion Verbindungstyp Tipo de conexión
	Input mode Pulse	Configurazione Ingresso Input configuration Configuration d'entrée Eingangskonfiguration Configuración de entrada
	Input pulse unit Wh	Unità di misura impulsi in ingresso Input pulse measurement unit Unité de mesure d'impulsion d'entrée Messeingangsimpulse Einheit Unidad de medida de pulso de entrada
	In. pulse weight 000.00 Wh	Peso impulsi in ingresso Input pulse weight Poids d'impulsion d'entrée Eingangsimpulsgewicht Peso de pulso de entrada
MID / no MID	Change psw 0000	Modifica Password Change Password Changer le mot de passe Kennwort ändern Cambiar contraseña
	Model: IM-CE4TB	CRC Software CRC Software CRC Software CRC Software
	Version: CRC:	

- Tenendo premuto il tasto **Set** per **3"** si accede alla visualizzazione dei parametri di setup
- Keeping the key **Set** pressed for **3 "** accesses the setup parameters display.
- En maintenant enfoncé le bouton **Set** pendant **3 "** pour accéder à l'affichage des paramètres de configuration.
- Durch Drücken der Taste **Set** für **3 "** wird die Anzeige der Setup-Parameter aufgerufen
- Si mantiene pulsado el botón **Set** durante **3 "** lleva a la pantalla de parámetros de configuración.

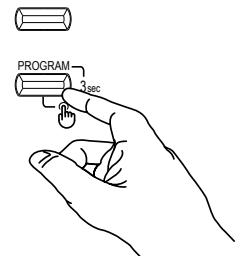

• Programmazione • Programming • Programmation • Programmierung
• Programación

Mbus

CE4DF3MTCL1
CE4DF3MTMID

MID / no MID	SETUP Primary address 000 [SET]	Indirizzo Primario Primary address Première adresse Primäradresse Dirección primera	
	SETUP Second. address 00000000 [SET]	Indirizzo Secondario Secondary address Adresse secondaire Sekundäre Adresse Dirección secundaria	
	SETUP Baudrate 2400 bit/s [SET]	Velocità di comunicazione Communication speed Vitesse de communication Kommunikationsgeschwindigkeit Velocidad de comunicación	
	SETUP Int. time (MD) 15 Minutes [SET]	Tempi di integrazione potenza media Tempo di integrazione potenza media Temps d'intégration moyen Durchschnittliche Power-Integrationszeit Tiempo medio de integración de potencia	
	SETUP Run hours thr 00.00% [SET]	Avvio conteggio Start counting Commencez comptage Beginnen Sie zu zählen Empezar a contar	
	SETUP KTA 0001 [SET]	Rapporto TA esterni External CT ratio Rapport des TC externes Verhältnis des externen CT Relación de CT externa	
	SETUP KTV 001.00 [SET]	Rapporto TV esterni External VT ratio Rapport des TP externes Verhältnis des externen VT Relación de VT externa	
	SETUP Wiring 3n-3E [SET]	Tipo di connessione Connection type Type de connexion Verbindungstyp Tipo de conexión	
	no MID	SETUP Input mode Pulse [SET]	Configurazione Ingresso Input configuration Configuration d'entrée Eingangskonfiguration Configuración de entrada
		SETUP Input pulse unit Wh [SET]	Unità di misura impulsi in ingresso Input pulse measurement unit Unité de mesure d'impulsion d'entrée Messeingangsimpulse Einheit Unidad de medida de pulso de entrada
SETUP In. pulse weight 000.00 Wh [SET]		Peso impulsi in ingresso Input pulse weight Poids d'impulsion d'entrée Eingangsimpulsgewichts Peso de pulso de entrada	
MID / no MID	SETUP Change psw 0000 [SET]	Modifica Password Change Password Changer le mot de passe Kennwort ändern Cambiar contraseña	
	SETUP Model: IM-CE4TB	CRC Software CRC Software CRC Software CRC Software CRC Software	
	SETUP Version: CRC:		

- Tenendo premuto il tasto **Set** per **3"** si accede alla visualizzazione dei parametri di setup
- Keeping the key **Set** pressed for **3 "** accesses the setup parameters display.
- En maintenant enfoncé le bouton **Set** pendant **3 "** pour accéder à l'affichage des paramètres de configuration.
- Durch Drücken der Taste **Set** für **3 "**wird die Anzeige der Setup-Parameter aufgerufen
- Si mantiene pulsado el botón **Set** durante **3 "** lleva a la pantalla de parámetros de configuración.

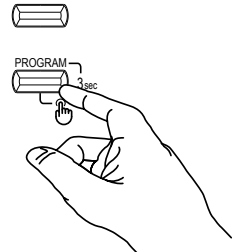

• Programmazione • Programming • Programmation • Programmierung
• Programación

CE4TB0PCL1
CE4TB0PMID

MID / no MID	SETUP	Int. time (MD)	5 Minutes	SET
	SETUP	Out. P. type	Ea+	SET
	SETUP	Out. P. weight	1 Wh	SET
	SETUP	Out. P. length	50 ms	SET
	SETUP	Run hours thr	00.00 %	SET
	SETUP	KTA	0001	SET
	SETUP	KTV	001.00	SET
	SETUP	Wiring	3n-3E	SET
	SETUP	Input pulse unit	Wh	SET
	SETUP	In. pulse weight	000.00 Wh	SET
	SETUP	Change psw	0000	SET
	SETUP	Model: IM-CE4TB		
	SETUP	Version:		
	SETUP	CRC:		

Tempo di integrazione potenza media

Tempo di integrazione potenza media
Temps d'intégration moyen
Durchschnittliche Power-Integrationszeit
Tiempo medio de integración de potencia

Tipo di energia da tradurre sull'uscita impulsi

Type of energy to be translated on the pulse output
Type d'énergie à transmettre en sortie d'impulsion
Energieart, die am Impulsausgang übersetzt werden soll
Tipo de energia a traducir en la salida de impulsos

Peso Impulso (kWh)

Pulse Weight (kWh)
Poids impulsion (kWh)
Impulsengewicht (kWh)
Peso del pulso (kWh)

Durata Impulso (msec)

Width of the pulse (msec)
Durée d'impulsion (msec)
Impulsdauer (msec)
Duración del impulso (ms)

Avvio conteggio

Start counting
Commencez comptage
Beginnen Sie zu zählen
Empezar a contar

Rapporto TA esterni

External CT ratio
Rapport des TC externes
Verhältnis des externen CT
Relación de CT externa

Rapporto TV esterni

External VT ratio
Rapport des TP externes
Verhältnis des externen VT
Relación de VT externa

Tipo di connessione

Connection type
Type de connexion
Verbindungstyp
Tipo de conexión

Unità di misura impulsi in ingresso

Input pulse measurement unit
Unité de mesure d'impulsion d'entrée
Messeingangsimpulse Einheit
Unidad de medida de pulso de entrada

Peso impulsi in ingresso

Input pulse weight
Poids d'impulsion d'entrée
Eingangsimpulsengewichts
Peso de pulso de entrada

Modifica Password

Change Password
Changer le mot de passe
Kennwort ändern
Cambiar contraseña

CRC Software

CRC Software
CRC Software
CRC Software
CRC Software

- Tenendo premuto il tasto **Set** per **3"** si accede alla visualizzazione dei parametri di setup
- Keeping the key **Set** pressed for **3 "** accesses the setup parameters display.
- En maintenant enfoncé le bouton **Set** pendant **3 "** pour accéder à l'affichage des paramètres de configuration.
- Durch Drücken der Taste **Set** für **3 "** wird die Anzeige der Setup-Parameter aufgerufen
- Si mantiene pulsado el botón **Set** durante **3 "** lleva a la pantalla de parámetros de configuración.

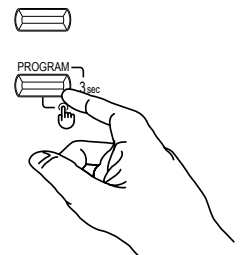

• Programmazione • Programming • Programmation • Programmierung • Programación

- Modifica dati di SETUP
- Changing SETUP data
- Modification des données SETUP
- Ändern der Setup-Daten
- Modificación de los datos de configuración

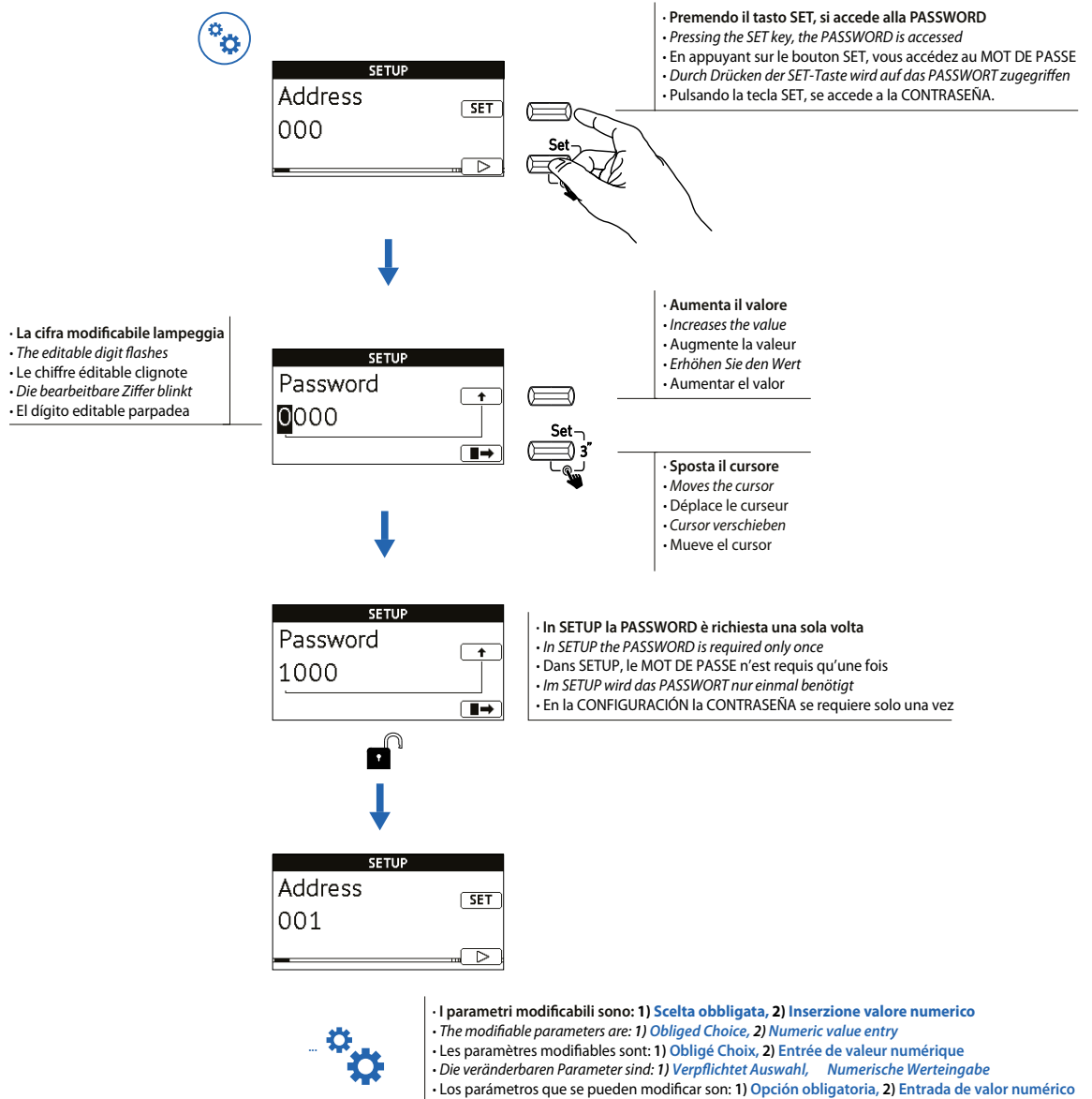

• Programmazione • Programming • Programmation • Programmierung • Programación

- I parametri modificabili sono:
- The modifiable parameters are:
- Les paramètres modifiables sont:
- Die veränderbaren Parameter sind:
- Los parámetros que se pueden modificar son:



1

- Scelta obbligata
- Obligated Choice
- Obligé Choix
- Verpflichtet Auswahl
- Opción obligatoria

- La cifra modificabile lampeggia
- The editable digit flashes
- Le chiffre éditabile clignote
- Die bearbeitbare Ziffer blinkt
- El dígito editable parpadea

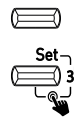
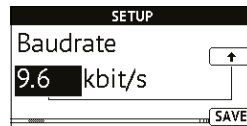

- Cambia la scelta
- Change the choice
- Changer le choix
- Ändern Sie die Auswahl
- Cambiar la elección

- Salva la modifica e sposta al setup successivo
- Save the change and move to the next setup
- Enregistrez la modification et passez à la configuration suivante
- Speichern Sie die Änderung und fahren Sie mit dem nächsten Setup fort
- Guarde el cambio y pase a la siguiente configuración

2

- Inserzione valore numerico
- Numeric value entry
- Entrée de valeur numérique
- Numerische Werteingabe
- Entrada de valor numérico

- La cifra modificabile lampeggia
- The editable digit flashes
- Le chiffre éditabile clignote
- Die bearbeitbare Ziffer blinkt
- El dígito editable parpadea

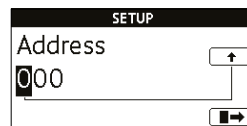

- Sposta alla cifra modificata successiva
- Move to the next digit modified
- Déplacer vers le chiffre suivant modifié
- Bewegen Sie zur nächsten Stelle geändert
- Mover a la siguiente figura modificada

x 2



- Aumenta il valore
- Increases the value
- Augmente la valeur
- Erhöhen Sie den Wert
- Aumentar el valor

- Salvare
- Save
- Sauver
- Speichern
- Salvar

x 1

• Comunicazione

Protocollo di comunicazione MODBUS

I contatori di energia con uscita MODBUS comunicano utilizzando la logica di comunicazione master/slave.

Tipologia di indirizzamento:

- punto-punto (il master comunica con un solo dispositivo slave alla volta).

La comunicazione avviene con modalità RTU (Remote Terminal Unit).

Sintassi di comunicazione:

Conformemente al protocollo MODBUS®, affinché un messaggio sia considerato valido dai contatori d'energia, il tempo massimo di attesa tra due parti del messaggio stesso deve essere inferiore a 3,5 volte il cosiddetto "tempo di intercarattere" (carattere = 8bit di dati).

Per la sintesi standard di comunicazione fare riferimento alle mappe di comunicazione MODBUS disponibili sul sito <http://www.imeitaly.com/>.

Il tipo di protocollo MODBUS usato è input Register a 16 bit.

Protocollo di comunicazione MBUS

I contatori di energia con uscita MBUS comunicano utilizzando la logica di comunicazione master/slave e seguono le indicazioni della specifica Standard EN13757-2.

Tipologia di indirizzamento:

- punto-punto (il master comunica con un solo dispositivo slave alla volta).

Sintassi di comunicazione:

Per la sintesi standard di comunicazione fare riferimento alle mappe di comunicazione MBUS disponibili sul sito http://www.imeitaly.com

• Communication

MODBUS communication protocol

Energy meters with MODBUS output communicate using the master / slave communication logic.

Type of addressing:

- *point-to-point (the master communicates with only one slave device at a time).*

Communication takes place in RTU (Remote Terminal Unit) mode.

Communication syntax:

In accordance with the MODBUS® protocol, for a message to be considered valid by the energy meters, the maximum waiting time between two parts of the message must be less than 3.5 times the so-called "inter-character time" (character = 8bit of data).

For the standard communication summary, refer to the MODBUS communication maps available on the website

<http://www.imeitaly.com/>.

The type of MODBUS protocol used is 16-bit input register.

MBUS communication protocol

Energy meters with MBUS output communicate using the master / slave communication logic and follow the indications of the Standard EN13757-2 specification.

Type of addressing:

- *point-to-point (the master communicates with only one slave device at a time).*

Communication syntax:

For the standard communication summary, refer to the MBUS communication maps available on the website

http://www.imeitaly.com

• Communication

Protocole de communication MODBUS

Les compteurs d'énergie avec sortie MODBUS communiquent en utilisant la logique de communication maître / esclave.

Type d'adressage:

- point à point (le maître ne communique qu'avec un seul appareil esclave à la fois).

La communication a lieu en mode RTU (Remote Terminal Unit).

Syntaxe de communication:

Conformément au protocole MODBUS®, pour qu'un message soit considéré comme valide par les compteurs d'énergie, le temps d'attente maximum entre deux parties du message doit être inférieur à 3,5 fois le temps dit "inter-caractères" (caractère = 8 bits de données).

Pour le récapitulatif de communication standard, reportez-vous aux plans de communication MODBUS disponibles sur le site <http://www.imeitaly.com/>.

Le type de protocole MODBUS utilisé est un registre d'entrée 16 bits.

Protocole de communication MBUS

Les compteurs d'énergie avec sortie MBUS communiquent en utilisant la logique de communication maître / esclave et suivent les indications de la spécification de la norme EN13757-2.

Type d'adressage:

- point à point (le maître ne communique qu'avec un seul appareil esclave à la fois).

Syntaxe de communication:

Pour le récapitulatif de communication standard, reportez-vous aux plans de communication MBUS disponibles sur le site

<http://www.imeitaly.com>

• Kommunikation

MODBUS-Kommunikationsprotokoll

Energiezähler mit MODBUS-Ausgang kommunizieren über die Master / Slave-Kommunikationslogik.

Art der Adressierung:

- Punkt-zu-Punkt (der Master kommuniziert jeweils nur mit einem Slave-Gerät).

Die Kommunikation erfolgt im RTU-Modus (Remote Terminal Unit).

Kommunikationssyntax:

Gemäß dem MODBUS®-Protokoll muss die maximale Wartezeit zwischen zwei Teilen der Nachricht weniger als das 3,5-fache der sogenannten "Zeit zwischen Zeichen" betragen (Zeichen = 8 Bit Daten), damit eine Nachricht von den Energiezählern als gültig angesehen wird).

Eine Zusammenfassung der Standardkommunikation finden Sie in den MODBUS-Kommunikationskarten auf der Website

<http://www.imeitaly.com/>.

Der verwendete MODBUS-Protokolltyp ist ein 16-Bit-Eingangsregister.

MBUS-Kommunikationsprotokoll

Energiezähler mit MBUS-Ausgang kommunizieren über die Master / Slave-Kommunikationslogik und folgen den Angaben der Norm EN13757-2.

Art der Adressierung:

- Punkt-zu-Punkt (der Master kommuniziert jeweils nur mit einem Slave-Gerät).

Kommunikationssyntax:

Eine Zusammenfassung der Standardkommunikation finden Sie in den MBUS-Kommunikationskarten auf der Website

<http://www.imeitaly.com>

• Comunicación

Protocolo de comunicación MODBUS

Los medidores de energía con salida MODBUS se comunican mediante la lógica de comunicación maestro / esclavo.

Tipo de direccionamiento:

- punto a punto (el maestro se comunica con un solo dispositivo esclavo a la vez).

La comunicación se realiza en modo RTU (Unidad terminal remota).

Sintaxis de comunicación:

De acuerdo con el protocolo MODBUS®, para que un mensaje sea considerado válido por los contadores de energía, el tiempo máximo de espera entre dos partes del mensaje debe ser inferior a 3,5 veces el denominado "tiempo entre caracteres" (carácter = 8 bits de datos).

Para obtener el resumen de comunicación estándar, consulte los mapas de comunicación MODBUS disponibles en el sitio web <http://www.imeitaly.com/>.

El tipo de protocolo MODBUS utilizado es el registro de entrada de 16 bits.

Protocolo de comunicación MBUS

Los contadores de energía con salida MBUS se comunican mediante la lógica de comunicación maestro / esclavo y siguen las indicaciones de la especificación de la Norma EN13757-2.











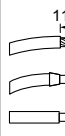
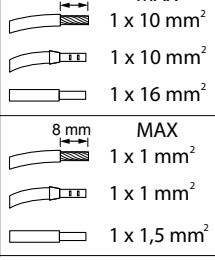

Tipo de direccionamiento:

- punto a punto (el maestro se comunica con un solo dispositivo esclavo a la vez).

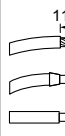
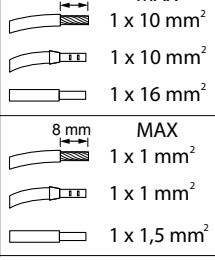
Sintaxis de comunicación:

Para obtener el resumen de comunicación estándar, consulte los mapas de comunicación MBUS disponibles en el sitio web <http://www.imeitaly.com/>

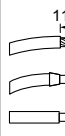
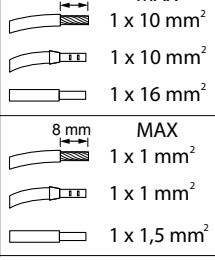
• Caratteristiche tecniche











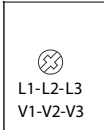
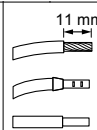
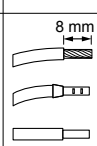

Involucro						
Dimensioni (l x h x p)	71,2 x 92,4 x 66mm					
Collegamenti	<table border="1" style="width: 100%; border-collapse: collapse;"> <tr> <td style="text-align: center;">  L1-L2-L3 V1-V2-V3 </td> <td style="text-align: center;">  1 C RS485 Mbus </td> <td style="text-align: center;">  11 mm MAX 8 mm MAX </td> <td style="text-align: center;">  1 x 10 mm² 1 x 10 mm² 1 x 16 mm² 1 x 1 mm² 1 x 1 mm² 1 x 1,5 mm² </td> <td style="text-align: center;"> Recommended torque 1,6 to 2Nm COMBI PZ2  Recommended torque 0,2Nm 0,5 x 2,5mm  </td> </tr> </table>	 L1-L2-L3 V1-V2-V3	 1 C RS485 Mbus	 11 mm MAX 8 mm MAX	 1 x 10 mm ² 1 x 10 mm ² 1 x 16 mm ² 1 x 1 mm ² 1 x 1 mm ² 1 x 1,5 mm ²	Recommended torque 1,6 to 2Nm COMBI PZ2  Recommended torque 0,2Nm 0,5 x 2,5mm 
 L1-L2-L3 V1-V2-V3	 1 C RS485 Mbus	 11 mm MAX 8 mm MAX	 1 x 10 mm ² 1 x 10 mm ² 1 x 16 mm ² 1 x 1 mm ² 1 x 1 mm ² 1 x 1,5 mm ²	Recommended torque 1,6 to 2Nm COMBI PZ2  Recommended torque 0,2Nm 0,5 x 2,5mm 		
Grado di protezione:	Frontale IP54, Morsetti IP20					
Peso:	210 g					
Display						
Tipo:	Grafico retroilluminato 1.8 pollici (256x128)					
Alimentazione ausiliaria						
Derivata dalle prese di tensione (Autoalimentato)						
Misura						
Rete trifase 3 e 4 fili						
Tensione (TRMS) Misura indiretta						
Tensione trifase nominale Un:	3x100...3x400V - 3x100/173...3x230/400V					
Autoconsumo circuito di tensione:	Max. 1,5VA trifase					
Corrente (TRMS) Misura indiretta	Cod. CE4TB0PCL1 - CE4TBDTCL1 - CE4TBMTC11	TA/1A - / 5A I _{min} : 0,01A - I _n : 5A - I _{max} : 6A				
	Cod. CE4TB0PMID - CE4TBDTMID - CE4TBMTC12	TA / 5A I _{min} : 0,05A - I _n : 5A - I _{max} : 6A				
Autoconsumo circuito di corrente:	Max. 1,8W per fase					
Sovraccarico di breve durata (IEC/EN 62053-21, IEC/EN 62053-23):	20 I _{max} / 0,5sec.					
Frequenza						
Frequenza nominale	F _n 50Hz; 60Hz					
Variazione ammessa	49...51 Hz, 59...61Hz					
Energie						
Cod. CE4TB0PCL1 - CE4TBDTCL1 - CE4TBMTC11	Classe di precisione Energia Attiva: 1 (IEC/EN 62053-21) Classe di precisione Energia Reattiva: 2 (IEC/EN 62053-23)					
Cod. CE4TB0PMID - CE4TBDTMID - CE4TBMTC12	Classe di precisione Energia Attiva: B (EN 50470-1, -3) Classe di precisione Energia Reattiva: 2 (IEC/EN 62053-23)					

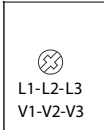
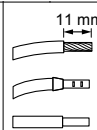
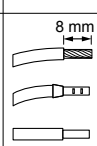
• Caratteristiche tecniche

Ingressi digitali	
Tensione:	12-24V DC
Corrente:	Max. 10 mA
Uscita impulsi	
Tipo:	Optorelè con contatto SPST-NO libero da potenziale
Tensione:	Max. 27V AC/DC
Corrente:	Max. 50 mA
Condizioni di utilizzo	
Temperatura di funzionamento:	(-25°C) ÷ (55°C) [-13°F ÷ 131°F]
Temperatura di immagazzinamento:	(-25°C) ÷ (70°C) [-13°F ÷ 158°F]
Umidità:	Adatto all'utilizzo in clima tropicale
Massima potenza dissipata:	≤ 10 W
Ambiente meccanico:	M1
Ambiente elettromagnetico:	E2
Umidità relativa:	95% senza condensa (EN50472-1)
Installazione:	Montaggio del contattore all'interno di un quadro IP51
Utilizzo:	Uso interno

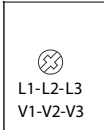
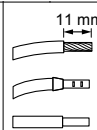
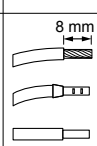
Marcatura CE	
I dispositivi CE4TB0PCL1 - CE4TBDTCL1 - CE4TBMTC11 - CE4TB0PMID - CE4TBDTMID - CE4TBMTC11 sono conformi: <ul style="list-style-type: none"> • Alle disposizioni della Direttiva Europea sulla compatibilità elettromagnetica (EMC) n° 2014/32/EU • Alla Direttiva bassa tensione n° 2014/35/UE. • Alla Direttiva 2011/65/EU modificata dalla direttiva 2015/863 (RoHS 2). 	
Compatibilità elettromagnetica	
Prove in accordo con IEC/EN 62052-11; EN 50470-1; EN 62053-21 e EN 50470-3	
Isolamento (IEC/EN 62052-11, IEC/EN 62053-21)	
Categoria di misura:	III
Grado d'inquinamento:	2
Tensione d'isolamento, Ui:	300V Fase-Terra
Tenuta all'impulso:	-Ingressi di misura / Ingressi digitali I/O: onda 1,2 / 50µs 0,5 J: 6kV tensione alternata 50Hz / 1 min.: 4kV -Tutti i circuiti /Massa tensione alternata 50Hz / 1 min.: 4kV
Superficie frontale:	Classe II

• Technical characteristics

Case											
Dimension (w x h x d)	71,2 x 92,4 x 66mm										
Connections	<table border="1" style="width: 100%; border-collapse: collapse;"> <tr> <td style="text-align: center; vertical-align: middle;">  L1-L2-L3 V1-V2-V3 </td> <td style="text-align: center; vertical-align: middle;">  1 C RS485 Mbus </td> <td style="text-align: center; vertical-align: middle;">  1 C RS485 Mbus </td> <td style="text-align: center; vertical-align: middle;"> 11 mm MAX 1 x 10 mm² 1 x 10 mm² 1 x 16 mm² </td> <td style="text-align: center; vertical-align: middle;"> Recommended torque 1,6 to 2Nm COMBI PZ2  </td> </tr> <tr> <td colspan="2"></td> <td style="text-align: center; vertical-align: middle;">  1 C RS485 Mbus </td> <td style="text-align: center; vertical-align: middle;"> 8 mm MAX 1 x 1 mm² 1 x 1 mm² 1 x 1,5 mm² </td> <td style="text-align: center; vertical-align: middle;"> Recommended torque 0,2Nm 0,5 x 2,5mm  </td> </tr> </table>	 L1-L2-L3 V1-V2-V3	 1 C RS485 Mbus	 1 C RS485 Mbus	11 mm MAX 1 x 10 mm ² 1 x 10 mm ² 1 x 16 mm ²	Recommended torque 1,6 to 2Nm COMBI PZ2 			 1 C RS485 Mbus	8 mm MAX 1 x 1 mm ² 1 x 1 mm ² 1 x 1,5 mm ²	Recommended torque 0,2Nm 0,5 x 2,5mm 
 L1-L2-L3 V1-V2-V3	 1 C RS485 Mbus	 1 C RS485 Mbus	11 mm MAX 1 x 10 mm ² 1 x 10 mm ² 1 x 16 mm ²	Recommended torque 1,6 to 2Nm COMBI PZ2 							
		 1 C RS485 Mbus	8 mm MAX 1 x 1 mm ² 1 x 1 mm ² 1 x 1,5 mm ²	Recommended torque 0,2Nm 0,5 x 2,5mm 							
Degree of protection	Front face IP54, Terminals IP20										
Weight:	210g										
Display											
Type:	Graphic, backlit 1.8 inches (256x128)										
Auxiliary supply											
Derived from the voltage terminals (Self-supplied)											
Measurement											
Three-phase 3 and 4-wire network											
Voltage (TRMS) Indirect measurement											
Three-phase rated voltage Un:	3x100...3x400V - 3x100/173...3x230/400V										
Power consumption voltage circuit:	Max. 1,5VA three-phase										
Current (TRMS) Indirect measurement	Cod. CE4TB0PCL1 - CE4TBDTCL1 - CE4TBMTC11	CT/1A - / 5A <i>I_{min}: 0,01A - I_n: 5A - I_{max}: 6A</i>									
	Cod. CE4TB0PMID - CE4TBDTMID - CE4TBMTC12	CT/ 5A <i>I_{min}: 0,05A - I_n: 5A - I_{max}: 6A</i>									
Current circuit power consumption	Max. 1,8W per phase										
Short-time overcurrent (IEC/EN 62053-21, IEC/EN 62053-23):	20 I _{max} / 0,5sec.										
Frequency											
Rated frequency	F _n 50Hz; 60Hz										
Permitted variation	49...51 Hz, 59...61Hz										
Energies											
Cod. CE4TB0PCL1 - CE4TBDTCL1 - CE4TBMTC11	Active energy accuracy class: 1 (IEC/EN 62053-21) Reactive energy accuracy class: 2 (IEC/EN 62053-23)										
Cod. CE4TB0PMID - CE4TBDTMID - CE4TBMTC12	Active energy accuracy class: B (EN 50470-1, -3) Reactive energy accuracy class: 2 (IEC/EN 62053-23)										

• Technical characteristics

Digital inputs	
Voltage:	12-24V DC
Current:	Max. 10 mA
Pulse output	
Type:	Optorelays with potential-free SPST-NO contact
Voltage:	Max. 27 V AC/DC
Current:	Max. 50 mA
Operating conditions	
Operating temperature:	(-25°C) ÷ (55°C) [-13°F ÷ 131°F]
Storage temperature:	(-25°C) ÷ (70°C) [-13°F ÷ 158°F]
Humidity:	Suitable for tropical climates
Max. dissipated power:	≤ 10 W
Mechanical environment:	M1
Electromagnetic environment:	E2
Relative humidity:	95% not condensing (EN50472-1)
Installation:	Mounting the KWH-meter in a IP51 switchboard
Use:	Indoor

CE Marking

The **CE4TB0PCL1 - CE4TBDTCL1 - CE4TBMTC11 - CE4TB0PMID - CE4TBDTMID - CE4TBMTCMID** devices comply with:

- The requirements of the European directive on electromagnetic compatibility (EMC) n° 2014/32/EU
- The low voltage directive n° 2014/35/UE.
- Directive 2011/65/EU modified by directive 2015/863 (RoHS 2).











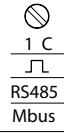









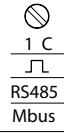





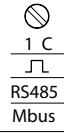

Electromagnetic compatibility

According to IEC/EN 62052-11; EN 50470-1; EN 62053-21 and EN 50470-3

Insulation (IEC/EN 62052-11, IEC/EN 62053-21)

Measurement category:	III
Degree of pollution:	2
Insulation voltage, U_i :	300V Phase-Earth
Impulse withstand voltage	- Measuring inputs / Digital I/O inputs wave 1,2 / 50µs 0,5 J: 6kV alternate voltage 50Hz / 1 min.: 4kV - All circuits / earth alternate voltage 50Hz / 1 min.: 4kV
Front surface:	Class II

• Caractéristiques techniques







Boîtier											
Dimensions (l x h x p)	71,2 x 92,4 x 66mm										
Raccordement:	<table border="1" style="width: 100%; border-collapse: collapse;"> <tr> <td style="text-align: center;">  L1-L2-L3 V1-V2-V3 </td> <td style="text-align: center;">  1 C RS485 Mbus </td> <td style="text-align: center;">  11 mm MAX 1 x 10 mm² </td> <td style="text-align: center;">  11 mm MAX 1 x 10 mm² </td> <td style="text-align: center;">  16 mm 1 x 16 mm² </td> <td style="text-align: center;">  8 mm MAX 1 x 1 mm² </td> <td style="text-align: center;">  8 mm MAX 1 x 1 mm² </td> <td style="text-align: center;">  1,5 mm 1 x 1,5 mm² </td> <td style="text-align: center;">  Recommended torque 1,6 to 2Nm COMBI PZ2 </td> <td style="text-align: center;">  Recommended torque 0,2Nm 0,5 x 2,5mm </td> </tr> </table>	 L1-L2-L3 V1-V2-V3	 1 C RS485 Mbus	 11 mm MAX 1 x 10 mm ²	 11 mm MAX 1 x 10 mm ²	 16 mm 1 x 16 mm ²	 8 mm MAX 1 x 1 mm ²	 8 mm MAX 1 x 1 mm ²	 1,5 mm 1 x 1,5 mm ²	 Recommended torque 1,6 to 2Nm COMBI PZ2	 Recommended torque 0,2Nm 0,5 x 2,5mm
 L1-L2-L3 V1-V2-V3	 1 C RS485 Mbus	 11 mm MAX 1 x 10 mm ²	 11 mm MAX 1 x 10 mm ²	 16 mm 1 x 16 mm ²	 8 mm MAX 1 x 1 mm ²	 8 mm MAX 1 x 1 mm ²	 1,5 mm 1 x 1,5 mm ²	 Recommended torque 1,6 to 2Nm COMBI PZ2	 Recommended torque 0,2Nm 0,5 x 2,5mm		
Indice de protection:	Face avant IP54, Bornes IP20										
Poids:	210 g										
Afficheur											
Type:	Graphic, rétroéclairage 1.8 pouces (256x128)										
Alimentation axiliaire											
Dérivée par le prises de tension (Auto-alimentée)											
Mesure											
Reseau triphasé 3 et 4 fils											
Tension (TRMS)											
Mesure indirecte											
Tension triphasée nominale Un:	3x100...3x400V - 3x100/173...3x230/400V										
Autoconsommation circuit de tension:	Max. 1,5VA triphasée										
Courant (TRMS) Mesure indirecte	Cod. CE4TB0PCL1 - CE4TBDTCL1 - CE4TBMTC11	TC/1A - / 5A I _{min} : 0,01A - I _n : 5A - I _{max} : 6A									
	Cod. CE4TB0PMID - CE4TBDTMID - CE4TBMTC12	TC/5A I _{min} : 0,05A - I _n : 5A - I _{max} : 6A									
Autoconsommation circuit de courant	Max. 1,8W par phase										
Surintensité de courte durée (IEC/EN 62053-21, IEC/EN 62053-23):	20 I _{max} / 0,5sec.										
Fréquence											
Fréquence nominale	F _n 50Hz; 60Hz										
Variation admise	49...51 Hz, 59...61Hz										
Energies											
Cod. CE4TB0PCL1 - CE4TBDTCL1 - CE4TBMTC11	Classe de précision Energie Active: 1 (IEC/EN 62053-21) Classe de précision Energie Réactive: 2 (IEC/EN 62053-23)										
Cod. CE4TB0PMID - CE4TBDTMID - CE4TBMTC12	Classe de précision Energie Active: B (EN 50470-1, -3) Classe de précision Energie Réactive: 2 (IEC/EN 62053-23)										

• Caractéristiques techniques

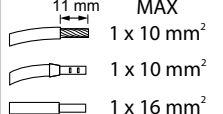
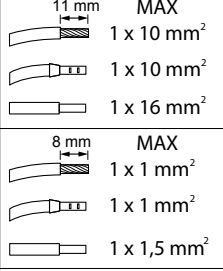
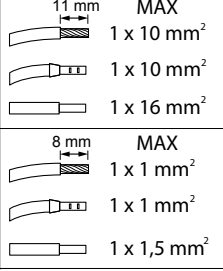
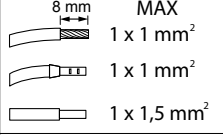
Entrée numérique	
Tension:	12-24V DC
Courant:	Max. 10 mA
Sortie impulsions	
Type:	Optorelays avec contact SPST-NO libre de potentiel
Tension:	Max. 27 V AC/DC
Courant:	Max. 50 mA
Conditions d' utilisation	
Température de fonctionnement:	(-25°C) ÷ (55°C) [-13°F ÷ 131°F]
Température de stockage:	(-25°C) ÷ (70°C) [-13°F ÷ 158°F]
Humidité:	Convient pour les climats tropicaux
Dissipation thermique:	≤ 10 W
Environnement mécanique:	M1
Environnement électromagnétique:	E2
Humidité relative:	95% sans condensation (EN50472-1)
Installation:	Installation du compteur dans un panneau IP51
Utilisation:	Utilisation interne

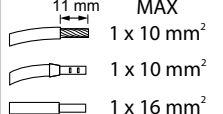
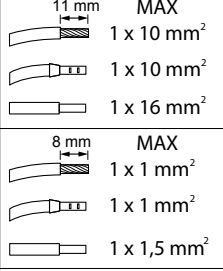
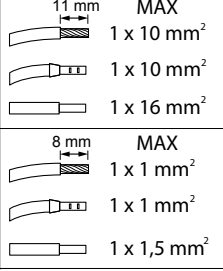
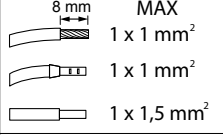
Marquage CE	
Le produits CE4TB0PCL1 - CE4TBDTCL1 - CE4TBMTC11 - CE4TB0PMID - CE4TBDTMID - CE4TBMTC11 répondent aux: <ul style="list-style-type: none"> • Dispositions de la directive européenne sur la compatibilité électromagnétique (CEM) n° 2014/32/UE • A directive basse tension n° 2014/35/EU. • A directive 2011/65/UE modifiée par directive 2015/863 (RoHS 2). 	
Compatibilité électromagnétique	
Essais conformément a IEC/EN 62052-11; EN 50470-1; EN 62053-21 et EN 50470-3	
Isolation (IEC/EN 62052-11, IEC/EN 62053-21)	
Catégorie de mesure:	III
Degré de pollution:	2
Tension d' isolation, Ui:	300V Phase-Terre
Tension de choc assignée:	- Entrée de mesure / Entrée I/O numérique: onda 1,2 / 50µs 0,5 J: 6kV tension alternatif 50Hz / 1 min.: 4kV -Tous les circuits /Terre: tension alternatif 50Hz / 1 min.: 4kV
Face avant:	Classe II

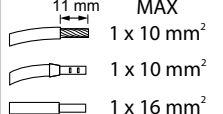
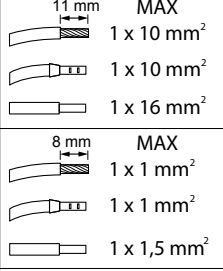
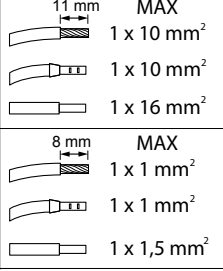
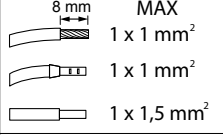
• Technische Daten



















Gehäuse							
Abmessung (L x H x T)	71,2 x 92,4 x 66mm						
Anschlüsse	<table border="1" style="width: 100%; border-collapse: collapse;"> <tr> <td style="padding: 5px; text-align: center;">  L1-L2-L3 V1-V2-V3 </td> <td style="padding: 5px; text-align: center;">  11 mm MAX 1 x 10 mm² 1 x 10 mm² 1 x 16 mm² </td> <td style="padding: 5px; text-align: center;"> Recommended torque 1,6 to 2Nm  COMBI PZ2 </td> </tr> <tr> <td style="padding: 5px; text-align: center;">  1 C RS485 Mbus </td> <td style="padding: 5px; text-align: center;">  8 mm MAX 1 x 1 mm² 1 x 1 mm² 1 x 1,5 mm² </td> <td style="padding: 5px; text-align: center;"> Recommended torque 0,2Nm 0,5 x 2,5mm  </td> </tr> </table>	 L1-L2-L3 V1-V2-V3	 11 mm MAX 1 x 10 mm ² 1 x 10 mm ² 1 x 16 mm ²	Recommended torque 1,6 to 2Nm  COMBI PZ2	 1 C RS485 Mbus	 8 mm MAX 1 x 1 mm ² 1 x 1 mm ² 1 x 1,5 mm ²	Recommended torque 0,2Nm 0,5 x 2,5mm 
 L1-L2-L3 V1-V2-V3	 11 mm MAX 1 x 10 mm ² 1 x 10 mm ² 1 x 16 mm ²	Recommended torque 1,6 to 2Nm  COMBI PZ2					
 1 C RS485 Mbus	 8 mm MAX 1 x 1 mm ² 1 x 1 mm ² 1 x 1,5 mm ²	Recommended torque 0,2Nm 0,5 x 2,5mm 					
Schutzklasse:	Frontal IP54, Klemmen IP20						
Gewicht:	210 g						
Display							
Typ:	Rückbeleuchtete Anzeige, 1.8 Zoll (256x128)						
Hilfsspannung							
Abgeleitet von den Spannungsanschlüssen (Selbstversorgung)							
Messung							
Drehstromnetz 3 und 4 Leiter							
Spannung (TRMS) Indirekte Messung							
Dreiphasige Nennspannung Un:	3x100...3x400V - 3x100/173...3x230/400V						
Selbstverbrauch Spannungskreis	Max. 1,5VA dreiphasig						
Strom (TRMS) Indirekte Messung	<table border="1" style="width: 100%; border-collapse: collapse;"> <tr> <td style="padding: 5px;">Cod. CE4TB0PCL1 - CE4TBDTCL1 - CE4TBMTC11</td> <td style="padding: 5px;">CT/1A - / 5A <i>I_{min}: 0,01A - I_n: 5A - I_{max}: 6A</i></td> </tr> <tr> <td style="padding: 5px;">Cod. CE4TB0PMID - CE4TBDTMID - CE4TBMTC11</td> <td style="padding: 5px;">CT/ 5A <i>I_{min}: 0,05A - I_n: 5A - I_{max}: 6A</i></td> </tr> </table>	Cod. CE4TB0PCL1 - CE4TBDTCL1 - CE4TBMTC11	CT/1A - / 5A <i>I_{min}: 0,01A - I_n: 5A - I_{max}: 6A</i>	Cod. CE4TB0PMID - CE4TBDTMID - CE4TBMTC11	CT/ 5A <i>I_{min}: 0,05A - I_n: 5A - I_{max}: 6A</i>		
Cod. CE4TB0PCL1 - CE4TBDTCL1 - CE4TBMTC11	CT/1A - / 5A <i>I_{min}: 0,01A - I_n: 5A - I_{max}: 6A</i>						
Cod. CE4TB0PMID - CE4TBDTMID - CE4TBMTC11	CT/ 5A <i>I_{min}: 0,05A - I_n: 5A - I_{max}: 6A</i>						
Selbstverbrauch Stromkreis	Max. 1,8W pro Phase						
Kurzzeitige Überlastung (IEC/EN 62053-21, IEC/EN 62053-23):	20 I _{max} / 0,5sec.						
Frequenz							
Nennfrequenz	F _n 50Hz; 60Hz						
Spannungsanschlussklemmen	49...51 Hz, 59...61Hz						
Energie							
Cod. CE4TB0PCL1 - CE4TBDTCL1 - CE4TBMTC11	Genauigkeitsklasse Wirkenergie: 1 (IEC/EN 62053-21) Genauigkeitsklasse Blindenergie: 2 (IEC/EN 62053-23)						
Cod. CE4TB0PMID - CE4TBDTMID - CE4TBMTC11	Genauigkeitsklasse Wirkenergie: B (EN 50470-1, -3) Genauigkeitsklasse Blindenergie: 2 (IEC/EN 62053-23)						

• Technische Daten

Digitaleingänge	
Spannung:	12-24V DC
Strom:	Max. 10 mA
Impulsausgang	
Typ:	Optorelais mit SPST-NO Kontakt potentialfrei
Spannung:	Max. 27 V AC/DC
Strom:	Max. 50 mA
Gebrauchsbedingungen	
Betriebstemperatur:	(-25°C) ÷ (55°C) [-13°F ÷ 131°F]
Lagertemperatur:	(-25°C) ÷ (70°C) [-13°F ÷ 158°F]
Feuchtigkeit:	Geeignet für den Einsatz in tropischem Klima
Maximale Verlustleistung:	≤ 10 W
Mechanische Umgebung:	M1
Elektromagnetische Umgebung:	E2
Relative Feuchte:	95% ohne Kondensation (EN50472-1)
Installieren:	Montage des Zählers innerhalb eines IP51-Panels
Ausnutzung:	Interne Verwendung

CE-Kennzeichnung	
Die Geräte CE4TB0PCL1 - CE4TBDTCL1 - CE4TBMTC11 - CE4TB0PMID - CE4TBDTMID - CE4TBMTCMID entsprechen <ul style="list-style-type: none"> • Den Bestimmungen der Europäischen Richtlinie über die elektromagnetische Verträglichkeit (EMV) Nr. 2014/32/EU • Der Niederspannungsrichtlinie 2014/35/EU • Der Richtlinie 2011/65/EG geändert durch Richtlinie 2015/863 (RoHS 2) 	
Elektromagnetische Verträglichkeit	
Prüfungen gemäß IEC/EN 62052-11; EN 50470-1; EN 62053-21 und EN 50470-3	
Isolation (IEC/EN 62052-11, IEC/EN 62053-21)	
Messkategorie:	III
Verschmutzungsgrad:	2
Isolationsspannung, U _i :	300V Phase-Erde
Impulsdauer:	-Messeingänge / Digitale I / O-Eingänge: Welle 1,2 / 50µs 0,5 J: 6kV Wechselspannung 50Hz / 1 min.: 4kV -Alle Stromkreise /Masse Wechselspannung 50Hz / 1 min.: 4kV
Frontfläche:	Klasse II

• Características técnicas

Caja							
Dimensiones (l x h x p)	71,2 x 92,4 x 66mm						
Conexión	<table border="1" style="width: 100%; border-collapse: collapse;"> <tr> <td style="text-align: center; vertical-align: middle;">  L1-L2-L3 V1-V2-V3 </td> <td style="text-align: center; vertical-align: middle;">  1 C RS485 Mbus </td> <td style="text-align: center; vertical-align: middle;">  MAX 1 x 10 mm² 1 x 10 mm² 1 x 16 mm² </td> <td style="text-align: center; vertical-align: middle;">  MAX 1 x 1 mm² 1 x 1 mm² 1 x 1,5 mm² </td> <td style="text-align: center; vertical-align: middle;"> Recommended torque 1,6 to 2Nm COMBI PZ2  </td> <td style="text-align: center; vertical-align: middle;"> Recommended torque 0,2Nm 0,5 x 2,5mm  </td> </tr> </table>	 L1-L2-L3 V1-V2-V3	 1 C RS485 Mbus	 MAX 1 x 10 mm ² 1 x 10 mm ² 1 x 16 mm ²	 MAX 1 x 1 mm ² 1 x 1 mm ² 1 x 1,5 mm ²	Recommended torque 1,6 to 2Nm COMBI PZ2 	Recommended torque 0,2Nm 0,5 x 2,5mm 
 L1-L2-L3 V1-V2-V3	 1 C RS485 Mbus	 MAX 1 x 10 mm ² 1 x 10 mm ² 1 x 16 mm ²	 MAX 1 x 1 mm ² 1 x 1 mm ² 1 x 1,5 mm ²	Recommended torque 1,6 to 2Nm COMBI PZ2 	Recommended torque 0,2Nm 0,5 x 2,5mm 		
Indice de protección:	Frente IP54, Terminales IP20						
Peso:	210 g						
Visualizador							
Type:	Gráfico retroiluminado 1,8 pulgadas (256x128)						
Alimentación auxiliar							
Derivada de la toma de presión (autoalimentado)							
Medidas							
Red trifásica 3 o 4 hilos							
Tensión (TRMS) Medida indirecta							
Tensión trifásica nominal Un:	3x100...3x400V - 3x100/173...3x230/400V						
Autoconsumo circuito de tensión:	Máx. 1,5VA trifásica						
Corriente (TRMS) Medida indirecta	Cod. CE4TB0PCL1 - CE4TBDTCL1 - CE4TBMTCCL1 CT/1A - / 5A I _{min} : 0,01A - I _n : 5A - I _{max} : 6A						
	Cod. CE4TB0PMID - CE4TBDTMID - CE4TBMTCMID CT/ 5A I _{min} : 0,05A - I _n : 5A - I _{max} : 6A						
Autoconsumo circuito de corriente:	Máx. 1,8W por fase						
Sobrecorriente de breve duración (IEC/EN 62053-21, IEC/EN 62053-23):	20 I _{max} / 0,5sec.						
Frecuencia							
Frecuencia nominal	F _n 50Hz; 60Hz						
Variación admitida	49...51 Hz, 59...61Hz						
Energía							
Cod. CE4TB0PCL1 - CE4TBDTCL1 - CE4TBMTCCL1	Clase de precisión Energía Activa: 1 (IEC/EN 62053-21) Clase de precisión Energía Reactiva: 2 (IEC/EN 62053-23)						
Cod. CE4TB0PMID - CE4TBDTMID - CE4TBMTCMID	Clase de precisión Energía Activa: B (EN 50470-1, -3) Clase de precisión Energía Reactiva : 2 (IEC/EN 62053-23)						

• Características técnicas

Entradas digitales	
Tensión:	12-24V DC
Corriente:	Máx. 10 mA
Salida impulsos	
Tipo:	Opto-relé con contacto SPST-NO libre de potencial
Tensión:	Máx. 27 V AC/DC
Corriente:	Máx. 50 mA
Condiciones de uso	
Temperatura de funcionamiento:	(-25°C) ÷ (55°C) [-13°F ÷ 131°F]
Temperatura de almacenaje:	(-25°C) ÷ (70°C) [-13°F ÷ 158°F]
Humedad:	Apto para la utilización en un clima tropical
Máxima potencia disipada:	≤ 10 W
Entorno mecánico:	M1
Entorno electromagnético:	E2
Humedad relativa:	95% sin condensación (EN50472-1)
Instalación:	Montaje del medidor dentro de un panel IP51
Utilización:	Uso en interiores

Marcado CE	
Los dispositivos CE4TB0PCL1 - CE4TBDTCL1 - CE4TBMTC11 - CE4TB0PMID - CE4TBDTMID - CE4TBMTC11 son conformes: <ul style="list-style-type: none"> • A las disposiciones de la Directiva europea sobre la compatibilidad electromagnética (EMC) n.º 2014/32/EU • A la Directiva baja tensión n.º 2014/35/UE • A la Directiva 2011/65/EU modificada por la directiva 2015/863 (RoHS 2) 	
Compatibilidad electromagnética	
Pruebas en conformidad a IEC/EN 62052-11; EN 50470-1; EN 62053-21 y EN 50470-3	
Aislamiento (IEC/EN 62052-11, IEC/EN 62053-21)	
Categoría de medida:	III
Grado de polución:	2
Tensión de Aislamiento, Ui:	300V Fase-Tierra
Resistencia al impulso de tensión:	- Entradas de medición / Entradas digitales I/O: onda 1,2 / 50µs 0,5 J: 6kV tensión alterna 50Hz / 1 min.: 4kV -Todos los circuitos / Masa tensión alterna 50Hz / 1 min.: 4kV
Superficie frontal:	Clase II

IME

A Group brand |  **legrand**

BTicino S.p.A
Viale Borri, 231
21100 Varese (VA) ITALY
☎: +39 02 44 878.1
www.imeitaly.com



BTicino si riserva in qualsiasi momento il diritto di modificare i contenuti di questo opuscolo e di comunicare, in qualsiasi forma e modalità, i cambiamenti apportati allo stesso.
BTicino reserves at any time the right to modify the contents of this booklet and to communicate, in any form and modality, the changes brought to the same.